

STIGA



**Spare parts and accessories
Range 2024**

4 Robot mowers

- 4 Autonomous robot mowers
- 6 Wire-guided robot mowers

9 Lawn mowers

- 9 Battery lawn mowers
- 16 Petrol lawn mowers
- 27 Corded lawn mowers

28 Lawn tractors

- 28 Battery lawn tractors
- 32 Petrol lawn tractors
- 40 Lawn tractors accessories

45 Front mowers and axial mowers

- 45 Axial mowers
- 46 Petrol front mowers
- 50 Park decks
- 52 Front mowers and axial mowers accessories

56 Hand-held tools

- 56 Battery brushcutters
- 57 Battery grass trimmers
- 58 Petrol brushcutters
- 63 Corded grass trimmers
- 64 Battery pole and hedge trimmers
- 66 Petrol hedge trimmers
- 67 Corded hedge trimmers
- 68 Battery pole saws, pruner and chainsaws
- 70 Petrol pruners and chainsaws
- 73 Corded chainsaws
- 74 Battery blowers
- 75 Vacuum shredder
- 76 Petrol blowers
- 78 Battery multi-tool
- 79 Petrol multi-tool
- 80 Battery Multi-mate

82 Cleaning

- 82 Petrol sweepers
- 83 Push sweepers
- 84 Corded high-pressure cleaners
- 87 Battery snowthrowers
- 88 Petrol snowthrowers

90 Soil and ground care

- 90 Petrol scarifiers
- 91 Corded scarifiers
- 93 Petrol tillers

94 Accessories and consumables

- 94 Batteries
- 100 Lubricants and oil
- 102 Trimmer lines
- 104 Safety clothing

Autonomous robot mowers



Autonomous	A 10000	A 7500	A 5000	A 3000	A 1500	A 1000	A 750	A 500
Level	Expert	Expert	Expert	Expert	Experience	Experience	Experience	Experience
Art. N.	2R9106228/ST1	2R9106128/ST1	2R9106028/ST1	2R9102028/ST1	2R7102028/ST1	2R7101028/ST2	2R7101228/ST1	2R7101128/ST1
POWER								
Battery capacity	2 x 6 Ah	2 x 5 Ah	2 x 5 Ah	5 Ah	5 Ah	2.5 Ah	2.5 Ah	2.0 Ah
INSTALLATION								
Installation trolley	1127-0021-01	•	•	•	•	•	•	•
CHARGING								
Charging base pegs	1127-0008-01	•	•	•	•	•	•	•
Charging base extension cable 5 M	1127-0010-01	•	•	•	•	•	•	•
Charging base extension cable 15 M	1127-0020-01	•	•	•	•	•	•	•
Charging base cover small	1127-0011-01				•	•	•	•
Charging base cover big*	1127-0024-01	•	•	•	•			
Charging base	381795002/0	•	•	•	•	•	•	•
Power Supply 2Ah CE Plug	118204158/0				•	•	•	•
Power Supply 4Ah CE Plug	118204159/0	•	•	•				
Reference station	381795003/0	•	•	•	•	•	•	•
Winter charger*	1127-0022-01	•	•	•	•	•	•	•
MAINTANANCE/OTHER								
Cutting blades (12 pcs)	1127-0009-01	•	•	•	•	•	•	•
Mountain wheels*	1127-0023-01				•	•	•	•
Safety Key	381100700/0	•	•	•	•	•	•	•
Wheel Motor	381395003/1				•	•	•	•
Wheel Motor	381395007/0	•	•	•	•			
Blade Motor	381395002/1	•	•	•	•	•	•	•
Chassis sealing gasket	122280001/0				•	•	•	•
Chassis sealing gasket	122280006/0	•	•	•	•	•	•	•
Battery lid sealing gasket	122280002/0	• (x2)	• (x2)	• (x2)	• (x2)	•	•	•

* Start of production Q1 2024

Wire-guided robot mowers



Wire-guided		G 3600	G 1200	G 600	G 300
Level		Essential	Essential	Essential	Essential
Art. N.		2R5106018/ST1	2R3102018/ST2	2R3101018/ST2	2R3101118/ST1
POWER					
Battery capacity		2 x 5 Ah	5 Ah	2.5 Ah	2.0 Ah
INSTALLATION					
Installation KIT Small	1127-0012-01		•	•	•
Installation KIT Medium	1127-0013-01		•	•	•
Installation KIT Big	1127-0025-01	•			
Perimeter cable 150 M	1127-0000-01		•	•	•
Perimeter cable 300 M	1127-0001-01		•	•	•
Perimeter cable 500 M	1127-0002-01	•	•	•	•
Perimeter cable 1000 M	1127-0003-01	•	•	•	•
Perimeter cable connectors	1127-0004-01	•	•	•	•
Perimeter cable pegs	1127-0006-01	•	•	•	•
CHARGING					
Charging base connectors	1127-0005-01	•	•	•	•
Charging base fast connectors	1127-0004-01	•	•	•	•
Charging base pegs	1127-0008-01	•	•	•	•
Charging base extension cable 5 M	1127-0010-01	•	•	•	•
Charging base extension cable 15 M	1127-0020-01	•	•	•	•
Charging base cover small	1127-0011-01		•	•	•
Charging base cover big*	1127-0024-01	•			
Charging base	381795001/0	•	•	•	•
Power Supply 2Ah CE Plug	118204158/0	•	•	•	•
Winter charger*	1127-0022-01	•	•	•	•
MAINTANANCE/OTHER					
Cutting blades (12 pcs)	1127-0009-01	•	•	•	•
Mountain wheels*	1127-0023-01		•	•	•
Safety Key	381100700/0	•	•	•	•
Small garden resistor	122063053/0	•	•	•	•
Wheel Motor	381395003/1	•	•	•	•
Blade Motor	381395002/1	•	•	•	•
Chassis sealing gasket	122280001/0	•	•	•	•
Battery lid sealing gasket	122280002/0	•	•	•	•

* Start of production Q1 2024



Multiclip 547e

SPARE PARTS AND ACCESSORIES

Battery lawn mowers



Multiclip	747e V Kit	547e S Kit	547e Kit	547 AE Kit
Level	Experience	Experience	Experience	Experience
Art. N.	298473278/ST1	298472058/ST1	298471058/ST2	298471058/ST1
POWER				
Voltage	48 V	48 V	48 V	48 V
Battery capacity	2 x 4 Ah	2 x 4 Ah	4 Ah	4 Ah
Cutting width	45 cm	45 cm	45 cm	45 cm
MAINTANANCE				
BLADE				
181004158/0	1111-9249-02	•	•	•
BLADE HOLDER				
322463190/0	1111-9259-01	•	•	•
322463189/0	1111-9258-01	•		
BATTERY				
277014008/ST1	incl. (x2)	incl. (x2)	incl.	incl.
BATTERY CHARGER				
277020008/ST1 (EU)	O	O	incl.	incl.
277020208/ST1 EU)	incl.	incl.	O	O
277030008/ST1 (EU)	O	O	O	O
DIAGNOSTIC TOOL				
118810754/0	•	•	•	•
PROTECTIVE COVER				
1111-9225-01 "S"				
1111-9226-01 "L"	•	•	•	•
SCRAPER				
1111-9227-01	•	•	•	•

incl. = Included
O = Optional

Battery lawn mowers



Combi	753e V Kit	748e V Kit	344e Kit
Level	Experience	Experience	Essential
Art. N.	2L0537978/ST1	2L0487978/ST1	294426068/ST2
POWER			
Voltage	48 V	48 V	48 V
Battery capacity	2 x 5 Ah	2 x 4 Ah	5 Ah
Cutting width	51 cm	46 cm	42 cm
MAINTANANCE			
BLADE			
181004460/0	1111-9278-02	•	
181004462/0	1111-9906-01	•	
181004467/0	1111-9882-01		•
BLADE HOLDER			
322463190/0	1111-9259-01	•	•
BATTERY			
277014008/ST1		incl. (x2)	
277015008/ST1	incl. (x2)		S
BATTERY CHARGER			
277020008/ST1 (EU)	O	O	incl.
277020208/ST1 EU)	incl.	incl.	O
277030008/ST1 (EU)	O	O	O
DIAGNOSTIC TOOL			
118810754/0	•	•	•
PROTECTIVE COVER			
1111-9225-01 "S"			•
1111-9226-01 "L"	•	•	
SCRAPER			
1111-9227-01	•	•	•
MULCHING DEFLECTOR			
322140251/0	incl.		
322140250/0		incl.	
322140243/0			incl.

incl. = Included
O = Optional



Combi	340e Kit	336e Kit
Level	Essential	Essential
Art. N.	294386068/ST2	294346068/ST2
POWER		
Voltage	48 V	48 V
Battery capacity	4 Ah	2 Ah
Cutting width	38 cm	34 cm
MAINTANANCE		
BLADE		
181004465/0	1111-9308-01	•
181004466/0	1111-9307-01	•
BLADE HOLDER		
322463190/0	1111-9259-01	
BATTERY		
277012008/ST1		incl.
277014008/ST1	incl.	
BATTERY CHARGER		
277020008/ST1 (EU)	incl.	incl.
277020208/ST1 EU)	O	O
277030008/ST1 (EU)	O	O
DIAGNOSTIC TOOL		
118810754/0	•	•
PROTECTIVE COVER		
1111-9225-01 "S"	•	•
1111-9226-01 "L"		
SCRAPER		
1111-9227-01	•	•
MULCHING DEFLECTOR		
322140242/0	incl.	
322140241/0		incl.

incl. = Included
O = Optional

Battery lawn mowers



Twinclip	950e VR Kit	950e V Kit
Level	Expert	Expert
Art. N.	294519198/ST1	294513998/ST1
POWER		
Voltage	48 V	48 V
Battery capacity	2 x 7.5 Ah	2 x 7.5 Ah
Cutting width	48 cm	48 cm
MAINTANANCE		
BLADE		
181004415/0	1111-9256-02 •	•
BLADE HOLDER		
122463012/4	1111-9168-01 •	•
BATTERY		
277017008/ST1	incl. (x2)	incl. (x2)
BATTERY CHARGER		
277020008/ST1 (EU)	○	○
277020208/ST1 EU)	incl.	incl.
277030008/ST1 (EU)	○	○
DIAGNOSTIC TOOL		
118810754/0	•	•
PROTECTIVE COVER		
1111-9225-01 "S"		
1111-9226-01 "L"	•	•
SCRAPER		
1111-9227-01	•	•
MULCHING DEFLECTOR		
322109578/0		incl.
322109591/0	incl.	

incl. = Included
○ = Optional



Collector	548e S Kit	543e Kit	548 AE Kit	548 S AE Kit
Level	Experience	Experience	Experience	Experience
Art. N.	2L0486008/ST1	2L0431008/ST2	2L0485808/ST1	2L0482808/ST1
POWER				
Voltage	48 V	48 V	48 V	48 V
Battery capacity	2 x 4 Ah	4 Ah	4 Ah	2 x 4 Ah
Cutting width	46 cm	41 cm	46 cm	46 cm
MAINTANANCE				
BLADE				
181004341/3	1111-9142-02	•		
181004460/0	1111-9278-02 •		•	•
BLADE HOLDER				
322463190/0	1111-9259-01	•	•	
322463189/0	1111-9258-01 •			•
BATTERY				
277014008/ST1	incl. (x2)	incl.	incl.	incl. (x2)
BATTERY CHARGER				
277020008/ST1 (EU)	○	incl.	incl.	○
277020208/ST1 EU)	incl.	○	○	incl.
277030008/ST1 (EU)	○	○	○	○
DIAGNOSTIC TOOL				
118810754/0	•	•	•	•
PROTECTIVE COVER				
1111-9225-01 "S"				
1111-9226-01 "L"	•	•	•	•
SCRAPER				
1111-9227-01	•	•	•	•
MULCHING DEFLECTOR				
322140249/0		○		
322140250/0	○		○	○

incl. = Included
○ = Optional

Battery lawn mowers



Collector	543 AE Kit	140e Kit	136e Kit	132e Kit
Level	Experience	Essential	Essential	Essential
Art. N.	2L0431008/ST1	291382068/ST2	291342068/ST2	291302068/ST2
POWER				
Voltage	48 V	20 V	20 V	20 V
Battery capacity	4 Ah	2 x 4 Ah	2 x 2 Ah	4 Ah
Cutting width	41 cm	38 cm	34 cm	30 cm
MAINTANANCE				
BLADE				
118811090/0	1111-9872-01			•
118811177/0	1111-9875-01		•	
118811210/0	1111-9878-01	•		
181004341/3	1111-9142-02	•		
BLADE HOLDER				
1111-9259-01	1111-9909-01	•	•	•
322463190/0	1111-9259-01	•		
BATTERY				
271012008/ST1			incl. (x2)	
271014008/ST1		incl. (x2)		incl.
277014008/ST1	incl.			
BATTERY CHARGER				
277020008/ST1 (EU)	incl.			
277020208/ST1 EU)	○			
277030008/ST1 (EU)	○			
271020000/21 (EU)		○	○	incl.
271020100/21 (EU)		incl.	incl.	○
DIAGNOSTIC TOOL				
118810754/0	•	•	•	•
PROTECTIVE COVER				
1111-9225-01 "S"		•	•	•
1111-9226-01 "L"	•			
SCRAPER				
118810754/0	•	•	•	•
MULCHING DEFLECTOR				
322140249/0	○			

incl. = Included
○ = Optional



Aero	132e Kit
Level	Essential
Art. N.	298302068/ST1
POWER	
Voltage	20 V
Battery capacity	2 x 4 Ah
Cutting width	30 cm
MAINTANANCE	
BLADE	
118811421/0	1111-9873-01 •
BLADE HOLDER	
118811422/0	1111-9908-01 •
BATTERY	
271014008/ST1	incl. (x2)
BATTERY CHARGER	
271020000/21 (EU)	○
271020100/21 (EU)	incl.
DIAGNOSTIC TOOL	
118810754/0	•
PROTECTIVE COVER	
1111-9225-01 "S"	•
1111-9226-01 "L"	
SCRAPER	
1111-9227-01	•

incl. = Included
○ = Optional

Petrol lawn mowers



Multiclip	950 VE	750 S	747 SD	547 S
Level	Expert	Experience	Experience	Experience
Art. N.	291503548/ST1	291502048/ST2	298472848/ST2	298472048/ST2
POWER				
Engine brand	STIGA	STIGA	STIGA	STIGA
Engine model	ST 200 LS OHV Autochoke	ST 170 OHV Autochoke	ST 140 OHV Autochoke	ST 120 OHV Autochoke
Engine oil tank capacity	0.50 L	0.55 L	0.50 L	0.50 L
Engine oil type*	STIGA SAE 30	STIGA SAE 30	STIGA SAE 30	STIGA SAE 30
Cutting width	48 cm	48 cm	45 cm	45 cm
MAINTANANCE				
BLADE				
181004146/0	1111-9155-02	•	•	
181004158/0	1111-9249-02		•	•
BLADE HOLDER				
122465608/3	1111-9180-01	•	•	•
BELT				
135063801/0	1111-9905-01		•	•
135064105/0	1111-9903-01	•		
135064010/0	1111-9164-01	•		
SPARK PLUG				
118550658/0	K7RTC		•	•
1111-9206-01	RC12YC	•	•	
AIR FILTER				
118550257/0		•	•	
118550945/0			•	•
118550946/0			•	•
PROTECTIVE COVER				
1111-9225-01 "S"				
1111-9226-01 "L"	•	•	•	•
SCRAPER				
1111-9227-01	•	•	•	•
ENGINE SERVICE KIT				
1111-9301-01	ST 120 ST 140 ST 140 LS		•	•
1111-9289-01	ST 170 ST 170 LS ST 200 ST 200 LS	•	•	
OIL EXTRACTOR KIT				
1134-9188-01		•	•	•
ENGINE BATTERY				
118120067/0	incl.			
ENGINE BATTERY CHARGER				
118204152/1	incl.			

* More details on page: 100-101



Multiclip	547 D	547	47 S	47
Level	Experience	Experience	Essential	Essential
Art. N.	298471848/ST2	298471048/ST2	298472048/ST1	298471048/ST1
POWER				
Engine brand	STIGA	STIGA	STIGA	STIGA
Engine model	ST 120 OHV Autochoke	ST 120 OHV Autochoke	ST 120 OHV Autochoke	ST 120 OHV Autochoke
Engine oil tank capacity	0.50 L	0.50 L	0.50 L	0.50 L
Engine oil type*	STIGA SAE 30	STIGA SAE 30	STIGA SAE 30	STIGA SAE 30
Cutting width	45 cm	45 cm	45 cm	45 cm
MAINTANANCE				
BLADE				
181004158/0	1111-9249-02	•	•	•
BLADE HOLDER				
122465608/3	1111-9180-01		•	
122463020/2	1111-9891-01	•	•	•
BELT				
135063801/0	1111-9905-01		•	
SPARK PLUG				
118550658/0	K7RTC	•	•	•
AIR FILTER				
118550945/0		•	•	•
118550946/0		•	•	•
PROTECTIVE COVER				
1111-9225-01 "S"				
1111-9226-01 "L"	•	•	•	•
SCRAPER				
1111-9227-01	•	•	•	•
ENGINE SERVICE KIT				
1111-9301-01	ST 120 ST 140 ST 140 LS	•	•	•
OIL EXTRACTOR KIT				
1134-9188-01		•	•	•

* More details on page: 100-101

Petrol lawn mowers



Twinclick	955 V	950 V	955 VR
Level	Expert	Expert	Expert
Art. N.	294563838/ST1	294513048/ST1	294569048/ST1
POWER			
Engine brand	HONDA	STIGA	STIGA
Engine model	GCVx 170 OHV Autochoke	ST 200 OHV Autochoke	ST 200 OHV Autochoke
Engine oil tank capacity	0.40 L	0.50 L	0.50 L
Engine oil type*	STIGA SAE 30	STIGA SAE 30	STIGA SAE 30
Cutting width	53 cm	48 cm	53 cm
MAINTANANCE			
BLADE			
181004146/0	1111-9256-02	•	
181004158/0	1111-9257-02	•	•
BLADE HOLDER			
122465608/3	1111-9262-01	•	•
BELT			
135063801/0	1111-9264-01	•	
135064105/0	1111-9265-01	•	•
SPARK PLUG			
118552279/0	BPR5ES	•	
118550658/0	RC12YC	•	•
AIR FILTER			
118550257/0		•	•
118551671/0		•	
PROTECTIVE COVER			
1111-9225-01 "S"			
1111-9226-01 "L"	•	•	•
SCRAPER			
1111-9227-01	•	•	•
MULCHING DEFLECTOR			
322140247/0		incl.	
322140248/0	incl.		○
ENGINE SERVICE KIT			
1111-9289-01	ST 170 ST 170 LS ST 200 ST 200 LS	•	•
OIL EXTRACTOR KIT			
1134-9188-01		•	•

* More details on page: 100-101

incl. = Included
○ = Optional



Twinclick	950 VR	950 S
Level	Expert	Expert
Art. N.	294519048/ST1	294512048/ST1
POWER		
Engine brand	STIGA	STIGA
Engine model	ST 200 OHV Autochoke	ST 170 OHV Autochoke
Engine oil tank capacity	0.50 L	0.55 L
Engine oil type*	STIGA SAE 30	STIGA SAE 30
Cutting width	48 cm	48 cm
MAINTANANCE		
BLADE		
181004146/0	1111-9256-02	•
BLADE HOLDER		
122465608/3	1111-9262-01	•
122463020/2	1111-9183-01	•
BELT		
135063801/0	1111-9264-01	•
135064010/0	1111-9252-01	•
SPARK PLUG		
118550658/0	RC12YC	•
AIR FILTER		
118550257/0		•
PROTECTIVE COVER		
1111-9225-01 "S"		
1111-9226-01 "L"	•	•
SCRAPER		
1111-9227-01	•	•
MULCHING DEFLECTOR		
322140247/0	○	incl.
ENGINE SERVICE KIT		
1111-9289-01	ST 170 ST 170 LS ST 200 ST 200 LS	•
OIL EXTRACTOR KIT		
1134-9188-01		•

* More details on page: 100-101

incl. = Included
○ = Optional

Petrol lawn mowers



Collector	548 S	543 S	48 S	43
Level	Experience	Experience	Essential	Essential
Art. N.	2L0482048/ST2	2L0432048/ST2	2L0482048/ST1	2L0431048/ST1
POWER				
Engine brand	STIGA	STIGA	STIGA	STIGA
Engine model	ST 120 OHV Autochoke	ST 120 OHV Autochoke	ST 120 OHV Autochoke	ST 120 OHV Autochoke
Engine oil tank capacity	0.50 L	0.50 L	0.50 L	0.50 L
Engine oil type*	STIGA SAE 30	STIGA SAE 30	STIGA SAE 30	STIGA SAE 30
Cutting width	46 cm	41 cm	46 cm	41 cm
MAINTANANCE				
BLADE				
181004341/3	1111-9142-02	•		•
181004346/3	1111-9121-02		•	
181004415/0	1111-9256-02	•		
BLADE HOLDER				
122465608/3	1111-9180-01	•	•	
122463020/2	1111-9891-01			•
122465639/2	1111-9183-01	•		
BELT				
135063710/0	1111-9297-01	•		
135063800/0	1111-9123-01		•	
135063802/0	1111-9912-01	•		
SPARK PLUG				
118550658/0	K7RTC	•	•	•
AIR FILTER				
118550945/0		•	•	•
118550946/0		•	•	•
PROTECTIVE COVER				
1111-9225-01 "S"				
1111-9226-01 "L"	•	•	•	•
SCRAPER				
1111-9227-01	•	•	•	•
MULCHING DEFLECTOR				
322140247/0	○			
322140249/0		○		○
322140250/0			○	
ENGINE SERVICE KIT				
1111-9301-01	ST 120 ST 140 ST 140 LS	•	•	•
OIL EXTRACTOR KIT				
1134-9188-01		•	•	•

* More details on page: 100-101



Combi	955 VE	955 V	753 V	753 SE
Level	Expert	Expert	Experience	Experience
Art. N.	294557548/ST1	294557848/ST2	2L0537838/ST2	2L0536548/ST2
POWER				
Engine brand	STIGA	STIGA	HONDA	STIGA
Engine model	ST 200 LS OHV Autochoke	ST 200 OHV Autochoke	GCVx 170 OHV Autochoke	ST 170 LS OHV Autochoke
Engine oil tank capacity	0.50 L	0.50 L	0.40 L	0.55 L
Engine oil type*	STIGA SAE 30	STIGA SAE 30	STIGA 10W 30	STIGA SAE 30
Cutting width	53 cm	53 cm	51 cm	51 cm
MAINTANANCE				
BLADE				
181004459/0	1111-9293-01		•	•
181004464/0	1111-9889-01	•	•	
BLADE HOLDER				
122465608/3	1111-9180-01	•	•	•
BELT				
135064196/0	1111-9296-01			•
135064378/0	1111-9900-01		•	
135064379/0	1111-9902-01	•	•	
SPARK PLUG				
118552279/0	BPR5ES		•	
1111-9206-01	RC12YC	•	•	•
AIR FILTER				
118550257/0		•	•	•
118551671/0			•	
PROTECTIVE COVER				
1111-9225-01 "S"				
1111-9226-01 "L"	•	•	•	•
SCRAPER				
1111-9227-01	•	•	•	•
ENGINE SERVICE KIT				
1111-9289-01	ST 170 ST 170 LS ST 200 ST 200 LS	•	•	•
OIL EXTRACTOR KIT				
1134-9188-01		•	•	•
ENGINE BATTERY				
118120067/0		incl.		incl.
ENGINE BATTERY CHARGER				
118204152/1		incl.		incl.
MULCHING DEFLECTOR				
322140246/0		incl.	incl.	incl.
322109602/1				incl.

* More details on page: 100-101

Petrol lawn mowers



Combi	753 S	748 V	748 SE	748 S
Level	Experience	Experience	Experience	Experience
Art. N.	2L0536848/ST2	2L0487838/ST2	2L0486548/ST2	2L0486848/ST2
POWER				
Engine brand	STIGA	HONDA	STIGA	STIGA
Engine model	ST 170 OHV Autochoke	GCVx145 OHV Autochoke	ST 140 LS OHV Autochoke	ST 140 OHV Autochoke
Engine oil tank capacity	0.55 L	0.40 L	0.50 L	0.50 L
Engine oil type*	STIGA SAE 30	STIGA 10W 30	STIGA SAE 30	STIGA SAE 30
Cutting width	51 cm	46 cm	46 cm	46 cm
MAINTANANCE				
BLADE				
181004346/3	1111-9121-02	•	•	•
181004459/0	1111-9293-01	•		
BLADE HOLDER				
122465608/3	1111-9180-01	•	•	•
BELT				
135063800/0	1111-9123-01		•	•
135064196/0	1111-9296-01	•		
135064395/0	1111-9904-01	•		
SPARK PLUG				
118550658/0	K7RTC			•
118552279/0	BPR5ES	•		
1111-9206-01	RC12YC	•	•	
AIR FILTER				
118550257/0		•	•	
118550945/0				•
118550946/0				•
118551671/0		•		
PROTECTIVE COVER				
1111-9225-01 "S"				
1111-9226-01 "L"	•	•	•	•
SCRAPER				
1111-9227-01	•	•	•	•
ENGINE SERVICE KIT				
1111-9301-01	ST 120 ST 140 ST 140 LS		•	•
1111-9289-01	ST 170 ST 170 LS ST 200 ST 200 LS	•		•
OIL EXTRACTOR KIT				
1134-9188-01	•	•	•	•
ENGINE BATTERY				
118120067/0			incl.	
ENGINE BATTERY CHARGER				
118204152/1			incl.	
MULCHING DEFLECTOR				
322109602/0	incl.	incl.	incl.	incl.



Combi	553 SE	553 S	548 SE	548 S
Level	Experience	Experience	Experience	Experience
Art. N.	2L0536648/ST1	2L0536048/ST1	2L0482548/ST1	2L0482348/ST1
POWER				
Engine brand	STIGA	STIGA	STIGA	STIGA
Engine model	ST 170 LS OHV Autochoke	ST 170 OHV Autochoke	ST 140 LS OHV Autochoke	ST 140 OHV Autochoke
Engine oil tank capacity	0.55 L	0.55 L	0.50 L	0.50 L
Engine oil type*	STIGA SAE 30	STIGA SAE 30	STIGA SAE 30	STIGA SAE 30
Cutting width	51 cm	51 cm	46 cm	46 cm
MAINTANANCE				
BLADE				
181004346/3	1111-9121-02		•	•
181004459/0	1111-9293-01	•	•	
BLADE HOLDER				
122465608/3	1111-9180-01	•	•	•
BELT				
135063800/0	1111-9123-01		•	•
135064196/0	1111-9296-01	•		
SPARK PLUG				
118550658/0	K7RTC			•
1111-9206-01	RC12YC	•	•	
AIR FILTER				
118550257/0		•	•	
118550945/0				•
118550946/0				•
118552623/0			•	
PROTECTIVE COVER				
1111-9225-01 "S"				
1111-9226-01 "L"	•	•	•	•
SCRAPER				
1111-9227-01	•	•	•	•
ENGINE SERVICE KIT				
1111-9301-01	ST 120 ST 140 ST 140 LS		•	•
1111-9289-01	ST 170 ST 170 LS ST 200 ST 200 LS	•	•	
OIL EXTRACTOR KIT				
1134-9188-01	•	•	•	•
ENGINE BATTERY				
118120067/0	incl.		incl.	
ENGINE BATTERY CHARGER				
118204152/1	incl.		incl.	
MULCHING DEFLECTOR				
322109602/0	incl.	incl.	incl.	incl.

* More details on page: 100-101

Petrol lawn mowers



Combi	55 SQ H	50 SQ H	53 S
Level	Experience	Experience	Essential
Art. N.	294556838/ST1	294502838/ST1	2L0536148/ST1
POWER			
Engine brand	HONDA	HONDA	STIGA
Engine model	GCVx200 OHV Autochoke	GCVx170 OHV Autochoke	ST 170 OHV Autochoke
Engine oil tank capacity	0.40 L	0.40 L	0.55 L
Engine oil type*	STIGA SAE 30	STIGA SAE 30	STIGA SAE 30
Cutting width	53 cm	48 cm	51 cm
MAINTANANCE			
BLADE			
181004366/2	1111-9907-01	•	
181004459/0	1111-9293-01		•
181004464/0	1111-9889-01	•	
BLADE HOLDER			
122465608/3	1111-9180-01	•	•
BELT			
135063900/0	1111-9898-01	•	
135063902/1	1111-9124-01	•	
135064196/0	1111-9296-01		•
SPARK PLUG			
118552279/0	BPR5ES	•	
1111-9206-01	RC12YC		•
AIR FILTER			
118550257/0			•
118551671/0	•	•	
118551672/0	•		
PROTECTIVE COVER			
1111-9225-01 "S"			
1111-9226-01 "L"	•	•	•
SCRAPER			
1111-9227-01	•	•	•
ENGINE SERVICE KIT			
1111-9289-01	ST 170 - ST 170 LS ST 200 - ST 200 LS		•
OIL EXTRACTOR KIT			
1134-9188-01	•	•	•
MULCHING DEFLECTOR			
322509595/0			incl.
322109584/0	incl.	incl.	

* More details on page: 100-101



Combi	48 S H	48 S
Level	Essential	Essential
Art. N.	2L0482138/ST1	2L0482248/ST1
POWER		
Engine brand	HONDA	STIGA
Engine model	GCVx145 OHV Autochoke	ST 140 OHV Autochoke
Engine oil tank capacity	0.40 L	0.50 L
Engine oil type*	STIGA SAE 30	STIGA SAE 30
Cutting width	46 cm	46 cm
MAINTANANCE		
BLADE		
181004346/3	1111-9121-02	•
BLADE HOLDER		
122465608/3	1111-9180-01	•
BELT		
135063800/0	1111-9123-01	•
SPARK PLUG		
118550658/0	K7RTC	•
118552279/0	BPR5ES	•
AIR FILTER		
118550945/0		•
118550946/0		•
118551671/0		•
PROTECTIVE COVER		
1111-9225-01 "S"		
1111-9226-01 "L"	•	•
SCRAPER		
1111-9227-01	•	•
ENGINE SERVICE KIT		
1111-9301-01	ST 120 ST 140 ST 140 LS	•
OIL EXTRACTOR KIT		
1134-9188-01	•	•
MULCHING DEFLECTOR		
322509595/0	incl.	incl.

* More details on page: 100-101

Petrol lawn mowers



Combi	48	43 SH
Level	Essential	Essential
Art. N.	2L0481048/ST1	2L0432038/ST1
POWER		
Engine brand	STIGA	HONDA
Engine model	ST 140 OHV Autochoke	GCVx145 OHV Autochoke
Engine oil tank capacity	0.50 L	0.40 L
Engine oil type*	STIGA SAE 30	STIGA SAE 30
Cutting width	46 cm	41 cm
MAINTANANCE		
BLADE		
181004341/3	1111-9142-02	•
181004346/3	1111-9121-02	•
BLADE HOLDER		
122465608/3	1111-9180-01	•
122463020/2	1111-9891-01	•
BELT		
135063710/0	1111-9297-01	•
SPARK PLUG		
118550658/0	K7RTC	•
118552279/0	BPR5ES	•
AIR FILTER		
118550945/0		•
118550946/0		•
118551671/0		•
PROTECTIVE COVER		
1111-9225-01 "S"		•
1111-9226-01 "L"		•
SCRAPER		
1111-9227-01		•
ENGINE SERVICE KIT		
1111-9301-01	ST 120 ST 140 ST 140 LS	•
OIL EXTRACTOR KIT		
1134-9188-01		•
MULCHING DEFLECTOR		
322509595/0	incl.	incl.

* More details on page: 100-101

Corded lawn mowers



Combi	340c	336c
Level	Essential	Essential
Art. N.	294380068/ST2	294340068/ST1
POWER		
Power	1.6 kW	1.4 kW
Cutting width	38 cm	34 cm
MAINTANANCE		
BLADE		
181004160/0	1111-9292-01	•
181004465/0	1111-9308-01	•
BLADE HOLDER		
322465602/1	1111-9623-01	•
PROTECTIVE COVER		
1111-9225-01 "S"		•
1111-9226-01 "L"		•
SCRAPER		
1111-9227-01		•
MULCHING DEFLECTOR		
322140242/0	incl.	
322140241/0		incl.

* More details on page: 100-101

Battery tractors



Estate	798e	584e	384e
Level	Experience	Experience	Essential
Art. N.	2T2800481/ST2	2T2205481/ST2	2T2200481/ST2
POWER			
Voltage	48V	48V	48V
Battery capacity	64 Ah	40 Ah	30 Ah
Cutting width	98 cm	84 cm	84 cm
Cutting method	Collecting	Collecting	Collecting
MAINTANANCE			
BLADE			
182004362/0 (R)	1134-9226-01 (pair)	incl.	
182004363/0 (L)	1134-9226-01 (pair)	incl.	
182004364/0 (R)	1134-9234-01 (pair)	O	
182004346/0 (L)	1134-9234-01 (pair)	O	
182004358/0 (R)	1134-9220-01 (pair)	incl.	incl.
182004359/0 (L)	1134-9220-01 (pair)	incl.	incl.
182004360/0 (R)	1134-9221-01 (pair)	O	O
182004361/0 (L)	1134-9221-01 (pair)	O	O
BLADE HOLDER			
125463200/0	1134-9159-01	•	•
BATTERY CHARGER			
182180179/3 (5Ah - EU)	O	O	incl.
182180180/1 (18Ah - EU)	incl.	incl.	O
DIAGNOSTIC TOOL			
118811349/0	1134-9635-01	•	•

incl. = Included
O= Optional



Tornado	7108e	598e	398e
Level	Experience	Experience	Essential
Art. N.	2T1270481/ST2	2T0665481/ST2	2T0660481/ST2
POWER			
Voltage	48V	48V	48V
Battery capacity	64 Ah	40 Ah	30 Ah
Cutting width	108 cm	98 cm	98 cm
Cutting method	Side discharge	Side discharge	Side discharge
MAINTANANCE			
BLADE			
182004346/0 (2x)	1134-9225-01	•	•
182004357/0 (2x)	1134-9231-01	•	
BLADE HOLDER			
125463200/0	1134-9159-01	•	•
BATTERY CHARGER			
182180179/3 (5Ah - EU)	O	O	incl.
182180180/1 (18Ah - EU)	incl.	incl.	O
DIAGNOSTIC TOOL			
118811349/0	1134-9635-01	•	•

incl.= Included
O= Optional

Battery tractors



Swift	372e	
Level	Experience	
Art. N.	2T0250481/ST1	
POWER		
Power source	Lithium-ion battery	
Voltage	48 V	
Battery capacity	3 x 5 Ah	
Cutting width	72 cm	
Cutting method	Collecting	
MAINTANANCE		
BLADE		
184109506/0 (R)	1134-9252-01 (pair)	•
184109507/0 (L)	1134-9252-01 (pair)	•
BLADE HOLDER		
125463201/0	1134-9253-01	•
BATTERY		
277015008/ST1	incl. (x3)	
277017008/ST1	O	
BATTERY CHARGER		
277020008/ST1 (EU)	O	
277020208/ST1 EU)	O	
277030008/ST1 (EU)	O	
118204210/0 (EU)	incl.	
DIAGNOSTIC TOOL		
118811349/0	1134-9635-01	•
118810754/0	•	



incl= Included
O= Optional

Petrol tractors



Tornado	9121 W	7108 W	5108 W
Level	Expert	Experience	Experience
Art. N.	2T1945381/ST2	2T1835481/ST1	2T1220481/ST2
POWER			
Engine brand	Honda	STIGA	STIGA
Engine model	GXV 630	ST 650 Twin	ST 550 Twin
Engine oil tank capacity	1.7 L	1.7 L	1.7 L
Engine oil type*	STIGA SAE 30, STIGA 5W-30 STIGA 10W-30	STIGA SAE 30, STIGA 5W-30 STIGA 10W-30	STIGA SAE 30, STIGA 5W-30 STIGA 10W-30
Transmission type	Hydrostatic	Hydrostatic	Hydrostatic
Cutting width	121 cm	108 cm	108 cm
MAINTANANCE			
BLADE			
182004357/0 (2x)	1134-9231-01	•	•
182004370/0 (2x)	1134-9734-01	•	
182004359/0 (3x)	1134-9233-01	•	
182004361/0 (3x)	1134-9232-01	•	
BLADE HOLDER			
125463200/0	1134-9159-01	•	•
BELT			
135061506/1	1134-9730-01		•
135062018/0	1134-9703-01		•
135062020/1	1134-9738-01	•	•
135062027/0	1134-9209-01	•	
135062028/0	1134-9208-01	•	
SPARK PLUG			
9400-0289-01	RN9YC	•	•
118551707/0	ZFR5F	•	
OIL FILTER			
118551566/0		•	•
118551895/0		•	
AIR FILTER			
118551590/0		•	•
118551668/0		•	
BATTERY			
118120007/0		•	•
118120068/0		•	•
BATTERY CHARGER			
182180190/1	1134-9250-01	•	•
ENGINE SERVICE KIT			
1134-9402-01		•	•
OIL EXTRACTOR KIT			
1134-9188-01		•	•

* More details on page: 100-101



Tornado	5108	398	398 M
Level	Experience	Essential	Essential
Art. N.	2T1215481/ST1	2T0610481/ST1	2T0510481/ST3
POWER			
Engine brand	STIGA	STIGA	STIGA
Engine model	ST 500	ST 450	ST 400
Engine oil tank capacity	1.2 L	1.2 L	0.8 L
Engine oil type*	STIGA SAE 30, STIGA 5W-30 STIGA 10W-30	STIGA SAE 30, STIGA 5W-30 STIGA 10W-30	STIGA SAE 30, STIGA 5W-30 STIGA 10W-30
Transmission type	Hydrostatic	Hydrostatic	Mechanical
Cutting width	108 cm	98 cm	98 cm
MAINTANANCE			
BLADE			
182004346/0 (2x)	1134-9225-01	•	•
182004357/0 (2x)	1134-9231-01	•	
BLADE HOLDER			
125463200/0	1134-9159-01	•	•
BELT			
135061504/0	1134-9731-01	•	•
135061506/1	1134-9730-01	•	
135062003/1	1134-9714-01	•	•
135062014/0	1134-9706-01		•
SPARK PLUG			
1111-9206-01	RC12YC	•	•
AIR FILTER			
118550199/0		•	•
118551406/0			•
BATTERY			
118120007/0		•	•
118120068/0		•	•
BATTERY CHARGER			
182180190/1	1134-9250-01	•	•
ENGINE SERVICE KIT			
1134-9400-01			•
1134-9401-01		•	•
OIL EXTRACTOR KIT			
1134-9188-01		•	•

* More details on page 100-101

Petrol tractors



Estate	9122 WX	9102 WX	9122 W
Level	Expert	Expert	Expert
Art. N.	2T1535381/ST2	2T1430381/ST2	2T1310381/ST2
POWER			
Engine brand	Honda	Honda	Honda
Engine model	GXV 690	GXV 690	GXV 630
Engine oil tank capacity	1.7 L	1.7 L	1.7 L
Engine oil type*	STIGA SAE 30, STIGA 5W-30 STIGA 10W-30	STIGA SAE 30, STIGA 5W-30 STIGA 10W-30	STIGA SAE 30, STIGA 5W-30 STIGA 10W-30
Transmission type	Hydrostatic 4 WD	Hydrostatic 4 WD	Hydrostatic
Cutting width	122 cm	102 cm	122 cm
MAINTANANCE			
BLADE			
182004342/0 (L)	1134-9230-01 (pair)	•	•
182004343/0 (R)	1134-9230-01 (pair)	•	•
182004349/0 (L)	1134-9229-01 (pair)	•	•
182004350/0 (R)	1134-9229-01 (pair)	•	•
182004340/1 (L)	1134-9228-01 (pair)	•	•
182004341/1 (R)	1134-9228-01 (pair)	•	•
182004347/0 (L)	1134-9227-01 (pair)	•	•
182004348/0 (R)	1134-9227-01 (pair)	•	•
BLADE HOLDER			
125463200/0	1134-9159-01	•	•
BELT			
135062020/1	1134-9738-01	•	•
135062029/0	1134-9724-01	•	•
135062825/0	1134-9723-01	•	•
135062826/0	1134-9739-01	•	•
135062828/0	1134-9741-01	•	•
135065605/0	1134-9725-01	•	•
135065606/0	1134-9722-01	•	•
SPARK PLUG			
118551707/0	ZFR5F	•	•
OIL FILTER			
118551895/0	•	•	•
AIR FILTER			
118551668/0	•	•	•
BATTERY			
118120007/0	•	•	•
118120068/0	•	•	•
BATTERY CHARGER			
182180190/1	1134-9250-01	•	•
ENGINE SERVICE KIT			
1134-9402-01	•	•	•
OIL EXTRACTOR KIT			
1134-9188-01	•	•	•

* More details on page: 100-101



Estate	9102 W	7122 W	7102 W
Level	Expert	Experience	Experience
Art. N.	2T0980381/ST2	2T1310481/ST3	2T0970481/ST1
POWER			
Engine brand	Honda	STIGA	STIGA
Engine model	GXV 630	ST 650 Twin	ST 650 Twin
Engine oil tank capacity	1.7 L	1.7 L	1.7 L
Engine oil type*	STIGA SAE 30, STIGA 5W3-0 STIGA 10W-30	STIGA SAE 30, STIGA 5W-30 STIGA 10W-30	STIGA SAE 30, STIGA 5W-30 STIGA 10W-30
Transmission type	Hydrostatic	Hydrostatic	Hydrostatic
Cutting width	102 cm	122 cm	102 cm
MAINTANANCE			
BLADE			
182004342/0 (L)	1134-9230-01 (pair)	•	•
182004343/0 (R)	1134-9230-01 (pair)	•	•
182004349/0 (L)	1134-9229-01 (pair)	•	•
182004350/0 (R)	1134-9229-01 (pair)	•	•
182004340/1 (L)	1134-9228-01 (pair)	•	•
182004341/1 (R)	1134-9228-01 (pair)	•	•
182004347/0 (L)	1134-9227-01 (pair)	•	•
182004348/0 (R)	1134-9227-01 (pair)	•	•
BLADE HOLDER			
125463200/0	1134-9159-01	•	•
BELT			
135062020/1	1134-9738-01	•	•
135062825/0	1134-9723-01	•	•
135062827/0	1134-9721-01	•	•
135065605/0	1134-9725-01	•	•
135065606/0	1134-9722-01	•	•
SPARK PLUG			
9400-0289-01	RN9YC	•	•
118551707/0	ZFR5F	•	•
OIL FILTER			
118551566/0	•	•	•
118551895/0	•	•	•
AIR FILTER			
118551590/0	•	•	•
118551668/0	•	•	•
BATTERY			
118120007/0	•	•	•
118120068/0	•	•	•
BATTERY CHARGER			
182180190/1	1134-9250-01	•	•
ENGINE SERVICE KIT			
1134-9402-01	•	•	•
OIL EXTRACTOR KIT			
1134-9188-01	•	•	•

* More details on page: 100-101

Petrol tractors



Estate	792 W	792	598 W
Level	Experience	Experience	Experience
Art. N.	2T0785481/ST1	2T0780481/ST1	2T2630481/ST2
POWER			
Engine brand	STIGA	STIGA	STIGA
Engine model	ST 600 Twin	ST 500	ST 550 Twin
Engine oil tank capacity	1.7 L	1.2 L	1.7 L
Engine oil type*	STIGA SAE 30, STIGA 5W-30 STIGA 10W-30	STIGA SAE 30, STIGA 5W-30 STIGA 10W-30	STIGA SAE 30, STIGA 5W-30 STIGA 10W-30
Transmission type	Hydrostatic	Hydrostatic	Hydrostatic
Cutting width	92 cm	92 cm	98 cm
MAINTANANCE			
BLADE			
182004344/1 (L)	1134-9224-01 (pair)	•	•
182004345/1 (R)	1134-9224-01 (pair)	•	•
182004353/0 (L)	1134-9222-01 (pair)	•	•
182004354/0 (R)	1134-9222-01 (pair)	•	•
182004363/0 (L)	1134-9226-01 (pair)		•
182004362/0 (R)	1134-9226-01 (pair)		•
182004346/0 (L)	1134-9234-01 (pair)		•
182004364/0 (R)	1134-9234-01 (pair)		•
BLADE HOLDER			
125463200/0	1134-9159-01	•	•
BELT			
135061509/0	1134-9718-01		•
135062020/1	1134-9738-01	•	•
135065700/0	1134-9720-01	•	•
SPARK PLUG			
9400-0289-01	RN9YC	•	•
1111-9206-01	RC12YC	•	•
OIL FILTER			
118551566/0		•	•
AIR FILTER			
118551590/0		•	•
118550199/0		•	•
BATTERY			
118120007/0		•	•
118120068/0		•	•
BATTERY CHARGER			
182180190/1	1134-9250-01	•	•
ENGINE SERVICE KIT			
1134-9401-01		•	•
1134-9402-01		•	•
OIL EXTRACTOR KIT			
1134-9188-01		•	•

* More details on page: 100-101



Estate	598	384	384 M
Level	Experience	Essential	Essential
Art. N.	2T2620481/ST2	2T2100481/ST1	2T2000481/ST3
POWER			
Engine brand	STIGA	STIGA	STIGA
Engine model	ST 500	ST 450	ST 400
Engine oil tank capacity	1.2 L	1.2 L	0.8 L
Engine oil type*	STIGA SAE 30, STIGA 5W-30 STIGA 10W-30	STIGA SAE 30, STIGA 5W-30 STIGA 10W-30	STIGA SAE 30, STIGA 5W-30 STIGA 10W-30
Transmission type	Hydrostatic	Hydrostatic	Mechanical
Cutting width	98 cm	84 cm	84 cm
MAINTANANCE			
BLADE			
182004363/0 (L)	1134-9226-01 (pair)	•	•
182004362/0 (R)	1134-9226-01 (pair)	•	•
182004346/0 (L)	1134-9234-01 (pair)	•	•
182004364/0 (R)	1134-9234-01 (pair)	•	•
182004358/0 (R)	1134-9220-01 (pair)	•	•
182004359/0 (L)	1134-9220-01 (pair)	•	•
182004360/0 (R)	1134-9221-01 (pair)	•	•
182004361/0 (L)	1134-9221-01 (pair)	•	•
BLADE HOLDER			
125463200/0	1134-9159-01	•	•
BELT			
135061508/0	1134-9729-01	•	•
135061509/0	1134-9718-01	•	•
135062018/0	1134-9703-01		•
135062020/1	1134-9738-01	•	•
SPARK PLUG			
1111-9206-01	RC12YC	•	•
AIR FILTER			
118550199/0		•	•
118551406/0			•
BATTERY			
118120007/0		•	•
118120068/0		•	•
BATTERY CHARGER			
182180190/1	1134-9250-01	•	•
ENGINE SERVICE KIT			
1134-9400-01			•
1134-9401-01		•	•
OIL EXTRACTOR KIT			
1134-9188-01		•	•

* More details on page: 100-101

Petrol tractors



Combi	372	166
Level	Essential	Essential
Art. N.	2T0210481/ST2	2T0070481/ST2
POWER		
Engine brand	STIGA	STIGA
Engine model	ST 400	ST 250 ES
Engine oil tank capacity	1.2 L	0.5 L
Engine oil type*	STIGA SAE 30, STIGA 5W-30 STIGA 10W-30	STIGA SAE 30, STIGA 5W-30 STIGA 10W-30
Transmission type	Hydrostatic	Hydrostatic
Cutting width	72 cm	66 cm
MAINTANANCE		
BLADE		
184109502/0	1134-9735-01	•
184109503/0	1134-9219-01	•
184109505/0	1134-9218-01	•
BLADE HOLDER		
125463200/0	1134-9159-01	•
BELT		
135061407/1	1134-9709-01	•
135061423/0G	1134-9727-01	•
135061428/0	1134-9728-01	•
135061429/0	1134-9713-01	•
SPARK PLUG		
1111-9206-01	RC12YC	•
AIR FILTER		
118550321/0		•
118551157/0		•
OIL EXTRACTOR KIT		
1134-9188-01		•

* More details on page: 100-101



Lawn tractors accessories

Description	Code	Pos.	Swift	Estate 3-5-7 Series	Tornado 3-5 Series	Tornado 7 Series	Combi 1-3 Series	Estate 3-5 Series	Estate 7-9 Series	Estate 9 Series(4WD)	Tornado 3-5 Series	Tornado 7-9 Series
Rear accessories (Trailer hitch needed)												
Combi cart	13-0952-11	1	•	•	•	•		•	•	•	•	•
Grass & leaves collector 42" compact	2A6107010/S17	2							•	•		•
Fertilizer spreader	13-0955-11	3		•	•	•		•	•	•	•	•
Poly roller 23"	299900260/0	4						•	•	•	•	•
Poly roller 36"	210800100/18	4						•	•	•	•	•
Sand spreader must order 182040074/0	13-1975-14	5								•		
	299900395/0	6		•				•				
	299900006/0	7							•			
Trailer hitch	299901006/0	8								•		
	299900385/0	9	•		•	•					•	
	210000000/17	10										•
Front accessories (PTO kit needed)												
Green keeper 110 cm (Multi Connect System)	211900100/17	11								•		
Flail mower 105 cm (Multi Connect System)	299900540/0	12							•			•
Snow blade 120 cm (Multi Connect System)	299900400/1	13							•			•
Snow blade 125 cm (Multi Connect System)	211300100/17	13								•		
Sweeper 105 cm (Multi Connect System)	299900500/1	14							•			•
Front rubber for sweeper 105 cm optional for 299900500/1	299900505/1	14							•			•
Sweeper 120 cm (Multi Connect System)	211200100/17	15								•		
PTO kit (Multi Connect System)	299900750/1	16							•			•
	211000100/17	17								•		
Other accessories												
Lawn striping kit	212120000/18	18								•		
Protective cover	1134-9177-01	19	•	•	•	•	•	•	•	•	•	•
	299900150/0	20							•	•		
Rear weight	210900100/17	21										•
Snow blade 107 cm	299903410/2	22		•	•	•		•			•	
Snow blade 120 cm	299900400/0	23							•			•
Snow chain 18"	299900470/1	24		•	•			•	•		•	
Snow chain 20"	299900480/1	24								•	•*	•
Winter tyres 18"	299900430/0	25		•	•	•		•	•		•	
Winter tyres 20"	211500000/18	25								•	•*	•
Phone holder	1134-9328-02	26	•	•	•	•	•	•			•	



* Compatible only with Tornado 5 Series (108 cm)

Lawn tractors accessories

Description	Code	Position	Fits for
Mulching kit			
	299900311/0	1	Swift 372e
Rear deflector	299900310/0	2	Estate 384e, Estate 584e, Estate 798e, Estate 384 M, Estate 384, Estate 598, Estate 598 W
	299900016/0	3	Estate 792, Estate 792 W, Estate 7102 W, Estate 7122 W, Estate 9102 W, Estate 9122 W, Estate 9102 WX, Estate 9122 WX
	299900044/0	4	Swift 372e
	299900135/0	5	Combi 166
	299900036/0	6	Combi 372
	210205000/19	7	Estate 384e, Estate 584e, Estate 384 M, Estate 384
	210205001/19	8	Estate 798e, Estate 598, Estate 598 W
Mulching kit plug	299900038/1	9	Estate 792, Estate 792 W
	299900055/0	10	Estate 7102 W, Estate 9102 W
	299900046/0	11	Estate 9122 W
	299901055/0	12	Estate 9102 WX
	299900341/0	13	Tornado 398e, Tornado 598e, Tornado 398 M, Tornado 398
	299900346/0	14	Tornado 7108e, Tornado 5108, Tornado 5108 W, Tornado 7108 W
	210300001/21	15	Tornado 9121 W
Mulching & side discharge kit	299900135/22	16	Combi 166
	299900037/0	17	Combi 372
	299900370/1	18	Estate 384e, Estate 584e, Estate 384 M, Estate 384
	299900374/0	19	Estate 798e, Estate 598, Estate 598 W
	299900070/1	20	Estate 792, Estate 792 W
Mulching kit (plug & blades)	299900074/0	21	Estate 7102 W, Estate 9102 W
	299900076/0	22	Estate 9122 W
	299901074/0	23	Estate 9102 WX
	210330000/17	24	Tornado 7108 W
	210300000/17	25	Tornado 9121 W

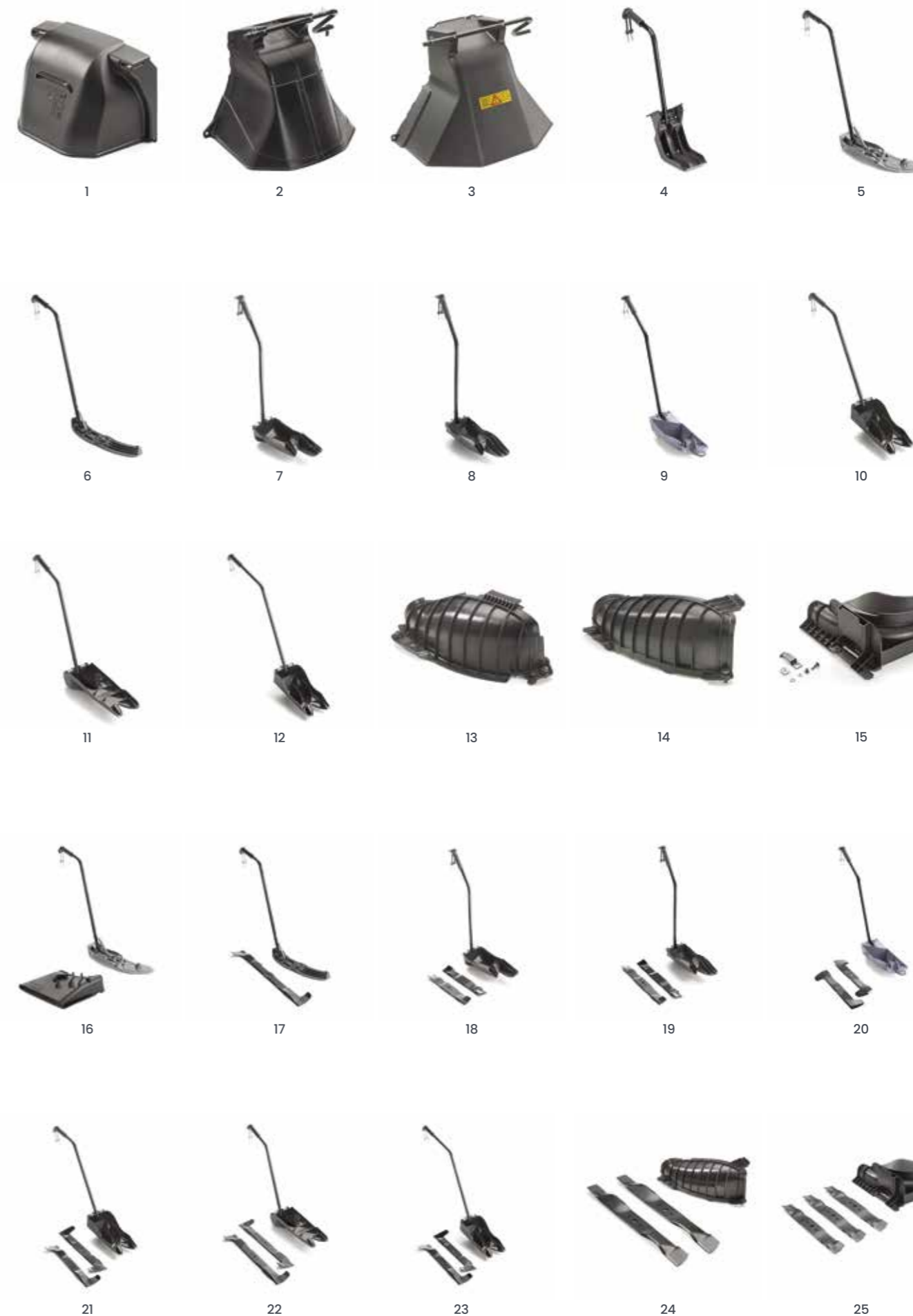



Gyro 700e

SPARE PARTS AND ACCESSORIES

Battery axial mowers



Gyro	900e	700e	500e
Level	Expert	Experience	Experience
Art. N.	2F7064705/ST1	2F7063605/ST1	2F7062505/ST1
POWER			
Voltage	48V	48V	48V
Battery capacity	105 Ah	64 Ah	40 Ah
Cutting width	125 cm	108 cm	98 cm
Cutting method	Rear discharge	Side discharge	Side discharge
MAINTANANCE			
BLADE			
182004346/0 (x2)	1134-9225-01		•
182004357/0 (x2)	1134-9231-01	•	
182004381/0 (x1)	1134-9251-01	•	
182004382/0 (x2)	1134-9251-01	•	
BLADE HOLDER			
125463200/0	1134-9159-01	• (x3)	• (x2)
BATTERY CHARGER			
182180180/1 (EU)		•	•
DIAGNOSTIC TOOL			
118811349/0	1134-9635-01	•	•

Petrol front mowers



Park Pro	900 AWX	900 WX
Level	Expert	Expert
Art. N.	2F6430931/ST2	2F6430831/ST2
POWER		
Engine brand	HONDA	HONDA
Engine model	GXV 690	GXV 630
Engine oil tank capacity	1.9 L	1.9 L
Engine oil type*	STIGA 10W-30	STIGA 10W-30
Transmission type	Hydrostatic	Hydrostatic
Cutting width	110 - 125 cm	110 - 125 cm
Transmission type	Hydrostatic	Hydrostatic
Transmission oil capacity	1.9 L	1.9 L
Transmission oil type*	STIGA 5W-50	STIGA 5W-50
TRANSMISSION BELT (A)		
9585-0091-01	1134-9058-01	•
PTO DRIVE BELT (B)		
9585-0147-01 (rear)	1134-9097-01	•
9585-0148-01 (front)	1134-9098-01	•
AIR FILTER		
118551668/0		•
SPARK PLUG		
118551707/0	ZFR5F	•
OIL EXTRACTOR KIT		
1134-9188-01		•
DIAGNOSTIC TOOL		
1134-9185-01		•

* More details on page: 100-101

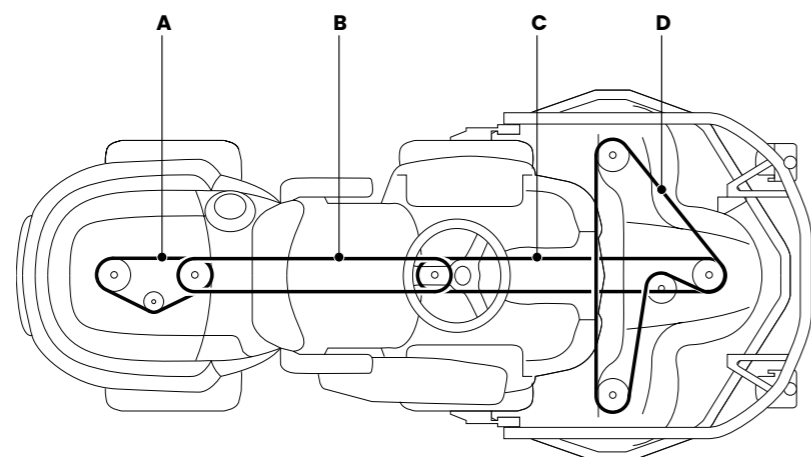

Park	900 WX	700 WX	700 W
Level	Expert	Experience	Experience
Art. N.	2F6230845/ST2	2F6230745/ST2	2F6220745/ST2
POWER			
Engine brand	STIGA	STIGA	STIGA
Engine model	ST 650 Twin	ST 600 Twin	ST 600 Twin
Engine oil tank capacity	1.7 L	1.7 L	1.7 L
Engine oil type*	STIGA SAE 30 STIGA 10W-30	STIGA SAE 30 STIGA 10W-30	STIGA SAE 30 STIGA 10W-30
Transmission type	Hydrostatic	Hydrostatic	Hydrostatic
Cutting width	95 - 125 cm	95 - 125 cm	95 - 125 cm
Transmission type	Hydrostatic	Hydrostatic	Hydrostatic
Transmission oil capacity	1.7 L	1.7 L	1.7 L
Transmission oil type*	STIGA 5W-50	STIGA 5W-50	STIGA 5W-50
TRANSMISSION BELT (A)			
9585-0091-01	1134-9058-01	•	•
PTO DRIVE BELT (B)			
135062030/0	1134-9239-01	•	•
9585-0088-00	1134-9047-01	•	•
AIR FILTER			
118551590/0		•	•
SPARK PLUG			
9400-0289-01	RN9YC	•	•
OIL FILTER			
118551566/0		•	•
ENGINE SERVICE KIT			
1134-9402-01		•	•
OIL EXTRACTOR KIT			
1134-9188-01		•	•

* More details on page: 100-101

Petrol front mowers



Park	500 WX	500 W	500
Level	Experience	Experience	Experience
Art. N.	2F6130645/ST2	2F6120645/ST2	2F6120545/ST2
POWER			
Engine brand	STIGA	STIGA	STIGA
Engine model	ST 550 Twin	ST 550 Twin	ST 450
Engine oil tank capacity	1.7 L	1.7 L	1.2 L
Engine oil type*	STIGA SAE 30 STIGA 10W-30	STIGA SAE 30 STIGA 10W-30	STIGA SAE 30 STIGA 10W-30
Transmission type	Hydrostatic	Hydrostatic	Hydrostatic
Cutting width	95 - 125 cm	95 - 110 cm	95 - 100 cm
Transmission type	Hydrostatic	Hydrostatic	Hydrostatic
Transmission oil capacity	1.7 L	1.7 L	1.2 L
Transmission oil type*	STIGA 5W-50	STIGA 5W-50	STIGA 5W-50
TRANSMISSION BELT (A)			
9585-0091-01	1134-9058-01	•	•
PTO DRIVE BELT (B)			
135062030/0	1134-9239-01	•	
9585-0088-00	1134-9047-01	•	•
AIR FILTER			
118551590/0		•	
118550199/0			•
SPARK PLUG			
9400-0289-01	RN9YC	•	
1111-9206-01	RC12YC		•
OIL FILTER			
118551566/0		•	
ENGINE SERVICE KIT			
1134-9402-01		•	
1134-9401-01			•
OIL EXTRACTOR KIT			
1134-9188-01		•	•

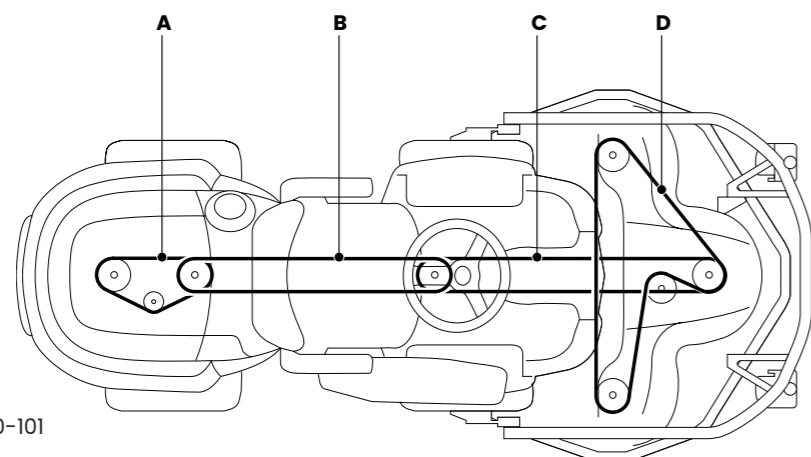

* More details on page: 100-101



Park	300	300 M
Level	Essential	Essential
Art. N.	2F5820421/ST2	2F5820241/S16
POWER		
Engine brand	STIGA	STIGA
Engine model	ST 450	ST 400
Engine oil tank capacity	1.2 L	1.2 L
Engine oil type*	STIGA SAE 30 STIGA 10W-30	STIGA SAE 30 STIGA 10W-30
Transmission type	Hydrostatic	Hydrostatic
Cutting width	85 - 95 cm	85 cm
Transmission type	Hydrostatic	Hydrostatic
Transmission oil capacity	2 L	2 L
Transmission oil type*	STIGA 5W-50	STIGA 5W-50
TRANSMISSION BELT (A)		
9585-0216-01	1134-9168-01	•
PTO DRIVE BELT (B)		
9585-0214-01 (rear)	1134-9172-01	•
9585-0215-01 (front)	1134-9167-01	•
AIR FILTER		
118550321/0		•
118550199/0		•
SPARK PLUG		
1111-9206-01	RC12YC	•
ENGINE SERVICE KIT		
1134-9401-01		•
OIL EXTRACTOR KIT		
1134-9188-01		•

* More details on page: 100-101

Park decks



	Combi Pro 125 Q Plus	Combi Pro 110 Q Plus	Combi 100 Q Plus
Art. N.	2D6312521/ST2	2D6311021/ST2	2D6210021/ST2
BLADE			
1134-9116-01			
1134-9117-01			
1134-9158-01			•
1134-9124-01		•	
1134-9125-01	•		
PTO – MOWER DECK BELT (C)			
1134-9241-01 Park 500 Park 500 W Park 700 W			
1134-9246-01 Park 500 WX Park 700 WX Park 900 WX			
1134-9186-01 Park 300 Park 300 M			
1134-9187-02 Park 300			
1134-9244-01 Park 500 Park 500 W Park 700 W			•
1134-9245-01 Park 500 WX Park 700 WX Park 900 WX			•
1134-9151-01 Park 500 W Park 700 W		•	
1134-9108-01 Park 500 WX Park 700 WX Park 900 WX Park Pro 900 WX Park Pro 900 AWX		•	
1134-9152-01 Park 700 W	•		
1134-9103-01 Park 500 WX Park 700 WX Park 900 WX Park Pro 900 WX Park Pro 900 AWX	•		
MOWER DECK BELT (D)			
1134-9198-02			
1134-9182-02			
1134-9183-02			
1134-9066-01			•
1134-9041-01		•	
1134-9087-01	•		

	Combi 95 Q Plus	Combi 95 Q	Combi 85 M Q
Art. N.	2D6209521/ST2	2D5809521/ST2	2D5808511/ST2
BLADE			
1134-9116-01	•	•	
1134-9117-01			
1134-9158-01			
1134-9124-01			
1134-9125-01			•
PTO – MOWER DECK BELT (C)			
1134-9241-01 Park 500 Park 500 W Park 700 W	•		
1134-9246-01 Park 500 WX Park 700 WX Park 900 WX	•		
1134-9186-01 Park 300 Park 300 M			•
1134-9187-02 Park 300		•	
1134-9244-01 Park 500 Park 500 W Park 700 W	•		
1134-9245-01 Park 500 WX Park 700 WX Park 900 WX	•		
1134-9151-01 Park 500 W Park 700 W			
1134-9108-01 Park 500 WX Park 700 WX Park 900 WX Park Pro 900 WX Park Pro 900 AWX			
1134-9152-01 Park 700 W			
1134-9103-01 Park 500 WX Park 700 WX Park 900 WX Park Pro 900 WX Park Pro 900 AWX			
MOWER DECK BELT (D)			
1134-9198-02	•		
1134-9182-02			•
1134-9183-02		•	
1134-9066-01			
1134-9041-01			
1134-9087-01			

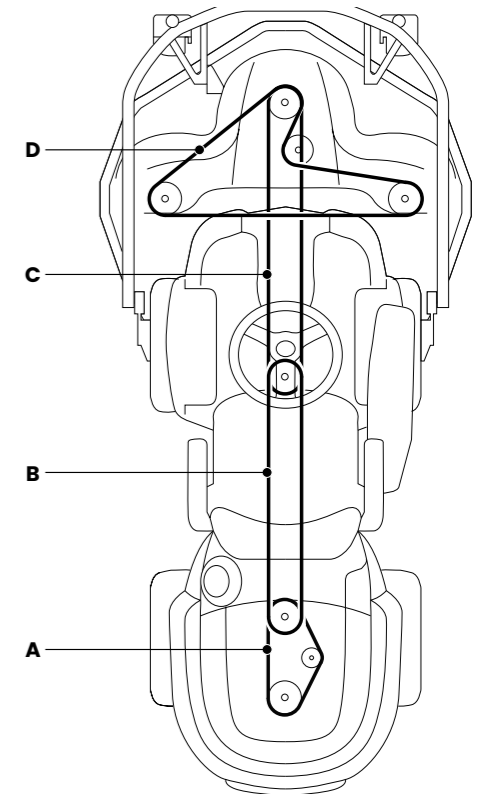

Front mowers and axial mowers accessories

Products	Code	Pos.	Park 300 M	Park 300	Park 500	Park 500 W	Park 500 WX	Park 700 W	Park 700 WX	Park 900 WX	Park Pro 900 WX	Park Pro 900 AWX	Gyro 500e	Gyro 700e	Gyro 900e
Rear accessories															
Combi cart plastic	13-0952-11	1	•	•	•	•	•	•	•	•	•	•	•	•	•
Fertiliser spreader	13-0955-11	2	•	•	•	•	•	•	•	•	•	•	•	•	•
Grass & leaf collector 42"	13-3926-11	3	•	•	•	•	•	•	•	•	•	•	•	•	•
Grass & leaf collector 42" compact	2A6107010/S17	4	•	•	•	•	•	•	•	•	•	•	•	•	•
Poly roller	299900260/0	5	•	•	•	•	•	•	•	•	•	•	•	•	•
Pro cart galvanized	13-3906-11	6	•	•	•	•	•	•	•	•	•	•	•	•	•
Rake tool 100 cm Park (in combination with tool lift)	13-3913-11	7	•	•	•	•	•	•	•	•	•	•	•	•	•
Rake tool 130 cm Park (in combination with tool lift)	13-3914-11	8						•	•	•	•	•	•	•	•
Rear tool lift, electric, Park	13-3919-11	9											•	•	•
Rear tool lift, manual, Park	13-3909-11	10						•	•	•	•	•	•	•	•
Sand spreader Park	13-1975-14	11						•	•	•	•	•	•	•	•
Front accessories															
Dust cover for sweeper 85 cm	13-3916-61	12			•	•	•	•	•	•	•	•	•	•	•
Dust cover for sweeper 95 cm	13-1936-62	12			•	•	•	•	•	•	•	•	•	•	•
Flail mower EL complete, Park 2+4 WD	13-3902-11	13						•	•	•	•	•	•	•	•
Flail mower, complete, Park 2+4 WD	13-0976-11	14						•	•	•	•	•	•	•	•
Lawn rake EL complete, Park 2+4 WD	13-3901-11	15						•	•	•	•	•	•	•	•
Lawn rake, complete, Park 2+4WD	13-0975-11	16						•	•	•	•	•	•	•	•
Rubber scraper bar 120 cm	13-1958-62	17			•	•	•	•	•	•	•	•	•	•	•
Rubber scraper hydraulic blade	13-3934-61	17													•
Rubber scraper hydraulic • blade	13-3933-61	18													•
Snow blade 120 cm Park	13-3917-61	19			•	•	•	•	•	•	•	•	•	•	•
Snow blade for Park 120 -220	2A3107020/S16	20	•	•											
Snow blade Park hydraulic	13-3932-11	21													•
Snow thrower 2-stage hydraulic	13-3930-11	22													•
Snow thrower 2-stage Park Pro	13-0922-12	23													•
Snow thrower Park 2+4WD	13-0974-11	24			•	•	•	•	•	•	•	•	•	•	•
Spring hoe	13-0978-61	25			•	•	•	•	•	•	•	•	•	•	•
Sweeper for Park 120 220	2A1100040/S16	26	•	•											
Sweeper Park 2+4 WD	13-0977-11	27			•	•	•	•	•	•	•	•	•	•	•
Sweeper Park hydraulic	13-3929-11	28													•
Sweeper Villa e Park 2+4WD	13-3918-61	29			•	•	•	•	•	•	•	•	•	•	•
Sweeper with collector	13-3910-11	30						•	•	•	•	•	•	•	•
• blade Park hydraulic	13-3931-11	31													•
Other accessories															
Carrier Case	2A4052000/S16	32											•	•	•
Comfort pack	1134-9329-01	N.A.											•	•	•
Edge cutter 2+4WD	13-3911-61	33			•	•	•	•	•	•	•	•	•	•	•
Frame weights 2x17 kg	13-0939-61	34			•	•	•	•	•	•	•	•	•	•	•
Mulching plug 98cm	299900341/0	35											•	•	•
Mulching plug 108cm	299900346/0	36												•	•
Mulching plug 125cm	299900349/0	N.A.													•
Protective cover STIGA	1134-9176-01	37	•	•	•	•	•	•	•	•	•	•	•	•	•
Side brush accessory	13-3915-11	38											•	•	•
Snow chains 16"x7,5	13-0936-61	39			•	•	•	•	•	•	•	•	•	•	•
Snow chains 160/50-8	13-3927-61	39	•	•											
Snow chains 17"x8	13-0937-61	39											•	•	•
Utility side pockets	1134-9740-01	N.A.													
Winter wheels Park, pair 16"	2A9000050/S16	40											•	•	•
Phone holder	1134-9328-02	41											•	•	•

SPARE PARTS AND ACCESSORIES



1. Combi cart



2. Fertiliser spreader



3. Grass & leaf collector 42"



4. Grass & leaf collector 42" compact



5. Poly Roller 23"



26. Sweeper



27. Sweeper



28. Sweeper



29. Sweeper



30. Sweeper



6. Pro cart galvanized



7. Rake tool 100 cm Park



8. Rake tool 130 cm Park



9. Rear tool lift electric



10. Rear tool lift manual



31. X blade Park Hydraulic



32. Carrier Case



33. Edge cutter 2+4WD



34. Frame weights 2x17 kg



35. Mulching plug 98 cm



11. Sand spreader



12. Dust cover for sweeper



13. Flail mower EL complete



14. Flail mower complete



15. Lawn rake EL complete



36. Mulching plug 108 cm



37. Protective cover STIGA



38. Side brush



39. Snow chains



40. Winter wheels



16. Lawn rake complete



17. Rubber scraper bar / blade



18. Rubber scraper blade



19. Snow blade



20. Snow blade



41. Phone holder



21. Snow blade



22. Snow thrower



23. Snow thrower



24. Snow thrower



25. Spring hoe

Battery brushcutters



	SBC 900 D AE	BC 700e B	BC 700e
Level	Expert	Experience	Experience
Art. N.	279210008/ST1	277210008/ST2	277200008/ST2
POWER			
Voltage	48V	48V	48V
Included battery capacity	5 Ah	4 Ah	4 Ah
TRIMMING			
TRIMMER HEAD			
M8-female, RH-thread, Ø102	1911-9299-01 118805046/0	•	•
M10-female, RH-thread, Ø102	1911-9300-01 118805046/0	•	
BLADE TYPE			
3 arc blade	- 118805533/0	•	•
Protection	- 118805553/0	•	
Protection	- 323465012/0	•	•
TRIMMER LINE			
Trimmer line Ø (1)	2.5 mm	2.0 mm	2.0 mm
BATTERY			
277012008/ST1		O	O
277014008/ST1	O	S	S
277015008/ST1	S	O	O
277017008/ST1	O	O	O
BATTERY CHARGER			
277020008/ST1 (EU)	O	O	O
277020208/ST1 EU)	O	O	O
277030008/ST1 (EU)	O	O	O
DIAGNOSTIC TOOL			
118810754/0	•	•	•
118811363/0	•	•	•

(1) More details on page: 102-103

incl.= Included
O= Optional
S= Suggested

Battery grass trimmers



	GT 500e	GT 300e Kit	GT 100e Kit
Level	Experience	Essential	Essential
Art. N.	278100008/ST3	273102501/ST1	271102108/ST2
POWER			
Voltage	48V	20V	20V
Included battery capacity	2 Ah	2 X 2Ah	2 Ah
TRIMMING			
TRIMMER HEAD			
Spool w. line	1911-9292-01 118805320/0		•
Spool w. line	1911-9251-01 118805048/0	•	
Spool w. line	1911-9301-01 118806447/0	•	
BLADE TYPE			
Protection	- 323465013/0	•	
Protection	- 118805321/0		•
Protection	- 118811564/0	•	
TRIMMER LINE			
Trimmer line Ø (1)	1.6 mm	1.6 mm	1.6 mm
BATTERY			
271012008/ST1		incl. (x2)	incl.
277012008/ST1	S		
277014008/ST1	O		
277015008/ST1	O		
277017008/ST1	O		
BATTERY CHARGER			
277020008/ST1 (EU)	O		
277020208/ST1 EU)	O		
277030008/ST1 (EU)	O		
271020000/21 (EU)		O	incl.
271020100/21 (EU)		O	O
1111-9329-01		incl.	
DIAGNOSTIC TOOL			
118810754/0	•		
118811363/0	•		

(1) More details on page: 102-103

incl.= Included
O= Optional
S= Suggested

Petrol brushcutters



	BC 760 B	BC 750 B	BC 750 R	BC 750	BC 740 B	BC 740	BC 730 B	BC 730	BC 555 B
Level	Experience	Experience	Experience	Experience	Experience	Experience	Experience	Experience	Experience
Art. N.	283524008/ST3	283424008/ST3	283423008/ST3	283420008/ST2	283321008/ST2	283320008/ST2	283221008/ST1	283220008/ST1	287421002/ST1
POWER									
Displacement	52.8 cc	44.80 cc	44.80 cc	44.80 cc	35.3 cc	35.3 cc	25.4 cc	25.4 cc	51.7 cc
Power	1.7 kW	1.5 kW	1.5 kW	1.5 kW	1.2 kW	1.2 kW	1 kW	1 kW	1.55 kW
Engine oil type*	STIGA 2-stroke oil	STIGA 2-stroke oil	STIGA 2-stroke oil	STIGA 2-stroke oil	STIGA 2-stroke oil	STIGA 2-stroke oil	STIGA 2-stroke oil	STIGA 2-stroke oil	STIGA 2-stroke oil
TRIMMING									
TRIMMER HEAD									
M10-female, LH-thread, Ø109	1911-9226-01						•	•	
M10-female, LH-thread, Ø130	1911-9227-01	118804530/0	•	•	•	•			•
BLADE TYPE									
3T blade	1911-9262-01	118801125/0	•	•	•	•	•	•	•
3 arc blade	1911-9263-01	118802009/0	•	•	•	•			•
4T blade	1911-9264-01	118802315/0	•	•	•	•	•	•	•
8T blade	1911-9265-01	118805083/0	•	•	•	•			•
24T blade	1911-9266-01	118805084/0	•	•		•			•
60T blade	-	118804180/0							•
Guard for blade (3,4,8T)	-	118805080/0	•	•	•	•			
Guard for blade (3,4,8T)	-	118805608/0					•	•	
Guard for blade (3T)	-	118803954/1							•
Saw blade guard for blade 24T (Ø30)	-	118805085/0	•	•		•			
Saw blade guard for blade 24T (Ø28)	-	118804181/0							•
Saw blade guard for blade 24T (Ø28)	1911-9269-01	-		•					•
Kit saw blade 24T + guard (Ø28)	1911-9258-01	-							•
Kit saw blade 24T + guard (Ø30)	1911-9290-01	-	•	•		•			
TRIMMER LINE									
Trimmer line Ø (1)	3 mm	3 mm	3 mm	3 mm	2.7 mm	2.7 mm	2.4 mm	2.4 mm	2.8 mm
AIR FILTER									
118805140/0	•	•	?	•	•	•			
118805595/0							•	•	
118805596/0							•	•	
118804547/0									•
SPARK PLUG									
118805138/0	BPMR7A	•	•	•	•	•	•	•	
3210024	RCJ7Y								•

* More details on page: 100-101

(1) More details on page: 102-103

Petrol brushcutters



	BC 555 R	BC 545 B	BC 545	BC 535 B	BC 535
Level	Experience	Experience	Experience	Experience	Experience
Art. N.	287422002/ST1	287321002/ST1	287320002/ST1	287221002/ST1	287220002/ST1
POWER					
Displacement	51.7 cc	42.7 cc	42.7 cc	32.6 cc	32.6 cc
Power	1.55 kW	1.25 kW	1.25 kW	0.9 kW	0.9 kW
Engine oil type*	STIGA 2-stroke oil	STIGA 2-stroke oil	STIGA 2-stroke oil	STIGA 2-stroke oil	STIGA 2-stroke oil
TRIMMING					
TRIMMER HEAD					
M10-female, LH-thread, Ø109	1911-9226-01	118801124/0		•	•
M10-female, LH-thread, Ø109	1911-9226-01	118804546/0		•	•
M10-female, LH-thread, Ø130	1911-9227-01	118804530/0	•		
BLADE TYPE					
3T blade	1911-9262-01	118801125/0	•	•	•
24T blade	-	118804179/0		•	
60T blade	-	118804180/0		•	
Guard for blade (3T)	-	118803939/0	•		
Guard for blade (3T)		118803198/0		•	•
Saw blade guard for blade 24T (Ø28)	-	118804181/0		•	
Saw blade guard for blade 24T (Ø28)	1911-9269-01	-		•	
Kit saw blade 24T + guard (Ø28)	1911-9258-01	-		•	
TRIMMER LINE					
Trimmer line Ø (1)		2.8 mm	2.8 mm	2.8 mm	2.4 mm
AIR FILTER					
118804547/0		•	•	•	•
118804074/0			•	•	•
SPARK PLUG					
3210024	RCJ7Y	•	•	•	•

* More details on page: 100-101

(1) More details on page: 102-103

Petrol brushcutters



	BC 330 AB	BC 330 A	GT 330 A
Level	Essential	Essential	Essential
Art. N.	287121102/ST2	287120102/ST2	287110102/ST2
POWER			
Displacement	25.4 cc	25.4 cc	25.4 cc
Power	0.7 kW	0.7 kW	0.7 kW
Engine oil type*	STIGA 2-stroke oil	STIGA 2-stroke oil	STIGA 2-stroke oil
TRIMMING			
TRIMMER HEAD			
M10-female, LH-thread, Ø109	1911-9226-01	118804682/0	•
M8-female, RH-thread, Ø109	1911-9197-02	118801753/0	•
BLADE TYPE			
3T blade	1911-9262-01	118801125/0	•
Protection	-	118803158/0	•
Guard for blade (3T)	-	118803939/0	•
Guard for blade (3T)		118803198/0	•
TRIMMER LINE			
Trimmer line Ø (1)	2.4 mm	2.4 mm	2.0 mm
AIR FILTER			
118801526/0		•	•
SPARK PLUG			
3210024	RCJ7Y	•	•

* More details on page: 100-101

(1) More details on page: 102-103

Corded grass trimmers



	GT 106c	GT 104c
Level	Essential	Essential
Art. N.	252060002/ST1	252035002/ST1
POWER		
Voltage	0.6 kW	0.35 kW
TRIMMING		
TRIMMER HEAD		
Spool w. line	1911-9125-01	•
Spool w. line	1911-9126-01	•
BLADE TYPE		
Protection	-	118800542/0
Protection	-	118800558/0
TRIMMER LINE		
Trimmer line Ø (1)	1.5 mm	1.4 mm

(1) More details on page: 102-103

Battery pole and hedge trimmers



	SPH 900 AE	SHT 900 AE	PH 700e	HT 500e	HT 300e Kit	HT 100 e Kit
Level	Expert	Expert	Experience	Experience	Essential	Essential
Art. N.	279710038/ST1	279300008/ST1	277710038/ST2	278300008/ST3	273302501/ST1	271302108/ST2
POWER						
Voltage	48V	48V	48V	48V	2 x 20V	20V
Battery capacity	2 x 7.5 Ah	5 Ah	2 Ah	2 Ah	2 x 2Ah	2 Ah
BLADE						
118811082/0						•
118811337/0		•				
118805535/0			•			
118811355/0	•					
118810817/0				•		
118811588/0					•	
BATTERY						
271012008/ST1					incl. (x2)	incl.
271014008/ST1						
277012008/ST1			S	S		
277014008/ST1	O	O	O	O		
277015008/ST1	O	S	O	O		
277017008/ST1	S (x2)	O	O	O		
BATTERY CHARGER						
277020008/ST1 (EU)	O	O	O	O		
277020208/ST1 EU	O	O	O	O		
277030008/ST1 (EU)	O	O	O	O		
271020000/21 (EU)					O	incl.
271020100/21 (EU)					O	O
1111-9329-01					incl.	
DIAGNOSTIC TOOL						
118810754/0	•	•	•	•		
118811363/0	•	•	•	•		

incl.= Included
 O= Optional
 S= Suggested

Petrol hedge trimmers



HT 525

Level	Experience
Art. N.	252421008/ST2
POWER	
Displacement	22.5 cc
Power	0.65 kW
Engine oil type*	STIGA 2-stroke oil
BLADE	
118805515/0	•
AIR FILTER	
118805493/0	•
SPARK PLUG	
118805554/0	L8RTC •

* More details on page: 100-101

Corded hedge trimmers



HT 106c HT 105c

Level	Essential	Essential
Art. N.	256060002/ST1	256050002/ST1
POWER		
Power	0.6 kW	0.5 kW
BLADE		
118800572/0		•
118800573/0	•	



Battery pole saws, pruners and chainsaw



	PS 900e	PS 700e	CS 700e	PR 700e	CS 300e Kit	CS 100e Kit
Level	Expert	Experience	Experience	Experience	Essential	Essential
Art. N.	279710048/ST2	277710048/ST2	277430008/ST1	278420008/ST3	273404501/ST1	271404101/ST1
POWER						
Voltage	48V	48V	48V	48V	2 X 20V	20V
Battery capacit	2 x 7.5 Ah	4 Ah	4 Ah	4 Ah	2 x 4 Ah	4 Ah
Chain oil type*	STIGA chain oil	STIGA chain oil	STIGA chain oil	STIGA chain oil	STIGA chain oil	STIGA chain oil
CHAIN						
STIGA Chain 91PX-40E 3/8"-0.050 (10")	1519-1001-40	123920363/0	•	•		
STIGA Chain 91PX-45E 3/8"-0.050 (12")	1519-1001-45	123920370/0		•		
STIGA Chain 91PX-52E 3/8"-0.050 (14")	1519-1001-52	123920373/0		•		
STIGA Chain CL143-40TL 3/8"-0.043" (10")	1519-1501-40	118806299/0				•
STIGA Chain CL143-45TL 3/8"-0.043" (12")	1519-1501-45	?			•	
BAR						
STIGA bar 100SDEA041 (10")	1519-4001-01	123900360/0	•	•		
STIGA bar 120SDEA041 (12")	1519-4002-01	123900362/0		•		
STIGA bar 140SDEA041 (14")	1519-4003-01	118811416/0		•		
STIGA bar M1431240-1041TL (10")	1519-4008-01	118806294/0				•
STIGA bar M1431245-1041TL (12")	1519-4009-01	118811549/0			•	
BATTERY						
271014008/ST1					incl. (x2)	incl.
277012008/ST1		o				
277014008/ST1	o	s	s	s		
277015008/ST1	o	o	o	o		
277017008/ST1	s (x2)	o	o	o		
BATTERY CHARGER						
277020008/ST1 (EU)	o	o	o	o		
277020208/ST1 (EU)	o	o	o	o		
277030008/ST1 (EU)	o	o	o	o		
271020000/21 (EU)					o	incl.
271020100/21 (EU)					o	o
1111-9329-01					incl.	
DIAGNOSTIC TOOL						
118810754/0	•	•	•	•		
118811363/0	•	•	•	•		

	SC 100e Kit
Level	Essential
Art. N.	257022001/ST1
POWER	
Voltage	20V
Battery capacit	2 Ah
BATTERY	
271012008/ST1	incl.
BATTERY CHARGER	
271020000/21 (EU)	incl.
271020100/21 (EU)	o

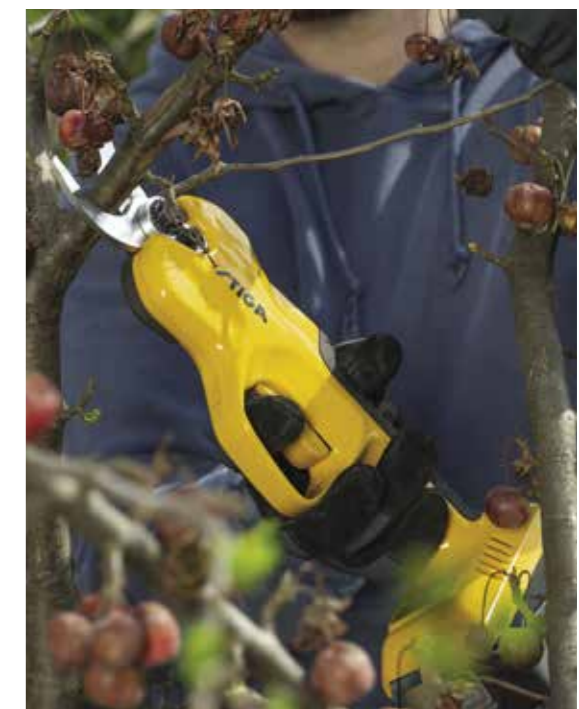

* More details on page: 100-101

incl.= Included
o= Optional
s= Suggested

Petrol pruners and chainsaws



	CS 755 (18")		CS 750 (18")		PR 730 C (10")		PR 730 (10")		CS 545 (16")		CS 540 (14")	
	Experience		Experience		Experience		Experience		Experience		Experience	
Art. N.	240521802/ST1		240461802/ST1		240271012/ST2		240271002/ST2		240421602/ST1		240381402/ST1	
POWER												
Displacement	52 cc		46.5 cc		26.9 cc		26.9 cc		42.4 cc		38.5 cc	
Power	2.3 kW		2 kW		0.7 kW		0.7 kW		1.9 kW		1.6 kW	
Engine oil type*	STIGA 2-stroke oil		STIGA 2-stroke oil		STIGA 2-stroke oil		STIGA 2-stroke oil		STIGA 2-stroke oil		STIGA 2-stroke oil	
Chain oil type*	STIGA chain oil		STIGA chain oil		STIGA chain oil		STIGA chain oil		STIGA chain oil		STIGA chain oil	
CHAIN												
STIGA Chain 91PX-40E-3/8"-0.050 (10")	1519-1001-40	123920363/0										
STIGA Chain 91PX-53E-3/8"-0.050 (14")	1519-1001-53	123920364/0										
STIGA Chain 21BPX-66E-0.325"-0.058 (16")	1519-1003-66	123920379/0										
STIGA Chain 21BPX-72E-0.325"-0.058 (18")	1519-1003-72	123920366/0	•	•								
STIGA Chain 25AP-60E-1/4"-0.050" (10")	1519-1008-60	123920383/0			•							
BAR												
STIGA bar 100SDEA041 (10")	1519-4001-01	123900360/0										
STIGA bar 140SDEA041 (14")	1519-4003-01	118800127/0										
STIGA bar 168PXBK095 (16")	1519-4005-01	123900302/0										
STIGA bar 188PXBK095 (18")	1519-4006-01	118800130/0	•	•								
STIGA bar AT10-50 (10")	1519-4007-01	118804663/0			•							
AIR FILTER												
118804926/0			•	•								
118804789/0					•		•					
118804908/0									•			•
SPARK PLUG												
3210024	RCJ7Y		•	•					•			•
1911-9221-02	CMR6A				•		•					

* More details on page: 100-101



CS 755

SPARE PARTS AND ACCESSORIES

Corded chainsaw



	CS 122c (16")		CS 118c (14")	
Level	Essential		Essential	
Art. N.	292616168/ST2		292614008/ST2	
POWER				
Power	2.2 kW		1.8 kW	
Chain oil type*	STIGA chain oil		STIGA chain oil	
CHAIN				
STIGA Chain 91PX-52E-3/8"-0.050 (14")	1519-1001-52	123920373/0	•	
STIGA Chain 91PX-56E-3/8"-0.050 (16")	1519-1001-56	123920365/0	•	
BAR				
STIGA bar 140SDEA041 (14")	1519-4003-01	118800127/0	•	
STIGA bar 160SDEA041 (16")	1519-4004-01	118800128/0	•	

* More details on page: 100-101

Battery blowers



	SAB 900 AE	BL 500e	BL 300e Kit	BL 100e Kit
Level	Expert	Experience	Essential	Essential
Art. N.	279500008/ST1	278500008/ST3	273504501/ST1	271504108/ST2
POWER				
Voltage	48V	48V	2 X 20V	20V
Power	0.8 kW	0.5 kW	0.5 kW	0.28 kW
Battery capacity	5 Ah	2 Ah	2 X 4 Ah	4 Ah
BATTERY				
271014008/ST1			incl. (X2)	incl.
277012008/ST1		S		
277014008/ST1	O	O		
277015008/ST1	S	O		
277017008/ST1	O	O		
BATTERY CHARGER				
277020008/ST1 (EU)	O	O		
277020208/ST1 EU)	O	O		
277030008/ST1 (EU)	O	O		
271020000/21 (EU)			O	incl.
271020100/21 (EU)			O	O
1111-9329-01			incl.	
DIAGNOSTIC TOOL				
118810754/0	•	•		
118811363/0	•	•		

incl.= Included
O= Optional
S= Suggested

Vacuum shredder



	VS 100e Kit
Level	Essential
Art. N.	
POWER	
Voltage	20V
Power	0.6 kW
Battery capacity	2 X 4 Ah
BATTERY	
271014008/ST1	incl.
BATTERY CHARGER	
271020000/21 (EU)	incl.
271020100/21 (EU)	O

incl.= Included
O= Optional
S= Suggested

Petrol blowers



	BL 980 R	BL 530 V	BL 530
Level	Expert	Experience	Experience
Art. N.	255175102/ST1	255127002/ST1	255127092/ST2
POWER			
Displacement	75.6 cc	27.6 cc	27.6 cc
Power	3.1 kW	0.8 kW	0.8 kW
Engine oil type*	STIGA 2-stroke oil	STIGA 2-stroke oil	STIGA 2-stroke oil
AIR FILTER			
118803089/0		•	•
118804444/0	•		
SPARK PLUG			
123051000/0	RZ7C	•	
3210024	RCJ7Y	•	•



* More details on page: 100-101

Battery multi-tool



	MT 500e Kit		MT 100e Kit	
	Experience		Essential	
Level				
Art. N.	278722108/ST3		271724108/ST2	
POWER				
Voltage	48V		20V	
Power (hedger function)	0.4 kW		0.15 kW	
Power (pruner function)	0.4 kW		0.28 kW	
Chain oil type*	STIGA chain oil		STIGA chain oil	
Battery capacity	2 Ah		4 Ah	
BLADE				
118811084/0			•	
118810893/0	•			
CHAIN				
STIGA Chain 91PX-33E-3/8"-0.050 (8")	1519-1001-33	123920368/0	•	
STIGA Chain 91PX-40E-3/8"-0.050 (10")	1519-1001-40	123920363/0	•	
BAR				
STIGA bar 080SDEA041 (8")	1519-4010-01	118804540/0	•	
STIGA bar 100SDEA041 (10")	1519-4001-01	123900360/0	•	
BATTERY				
271014008/ST1			incl.	
277012008/ST1	incl.			
277014008/ST1	O			
277015008/ST1	O			
277017008/ST1	O			
BATTERY CHARGER				
277020008/ST1 (EU)	incl.			
277020208/ST1 EU)	O			
277030008/ST1 (EU)	O			
271020000/21 (EU)			incl.	
271020100/21 (EU)			O	
DIAGNOSTIC TOOL				
118810754/0	•			
118811363/0	•			

* More details on page: 100-101

incl.= Included
O= Optional
S= Suggested

Petrol multi-tool



	MT 330 - 5 in 1			
	Experience			
Level				
Art. N.	287130152/ST2			
POWER				
Displacement	25.4 cc			
Power	0.7 kW			
Engine oil type*	STIGA 2-stroke oil			
Chain oil type*	STIGA chain oil			
BLADE				
118805733/0	•			
CHAIN				
STIGA Chain 91PX-40E-3/8"-0.050 (10")	1519-1001-40	123920363/0	•	
BAR				
STIGA bar 100SDEA041 (10")	1519-4010-01	123900360/0	•	
TRIMMING				
TRIMMER HEAD				
M10-female, LH-thread, Ø109	1911-9226-01	118801124/0	•	
BLADE TYPE				
3T blade	1911-9262-01	118801125/0	•	
Guard for blade (3T)	-	118803198/0	•	
TRIMMER LINE				
Trimmer line Ø (1)	2.4 mm			
AIR FILTER				
118801526/0	•			
SPARK PLUG				
3210024	RCJ7Y	•		

* More details on page: 100-101

(1) More details on page: 102-103

Battery multi-mate



	SGM 102 AE	SGM 72 AE
Level	Essential	Essential
Art. N.	253010241/ST1	253007231/ST1
POWER		
Voltage	10.8V	7.2V
Battery capacity	2.5 Ah	2.5 Ah
ACCESSORIES		
Grass blade 8 cm	232522011/ST1	•
Grass blade 11 cm	232522021/ST1	•
Grass blade 13 cm	232522031/ST1	•
Shrub blade 18 cm	232522041/ST1	•
Shrub blade 20 cm	232522051/ST1	•
Grubber	232523011/ST1	•
Pruning cutter	232523021/ST1	•
Telescopic handle	232521021/ST1	•
Textile bag	232524011/ST1	•
Battery charger 0,5 A (7.2 V)	1800-9009-01	•
Battery charger 0,5 A (10.8 V)	1800-9010-01	•
Battery charger 0,5 A (7.2 V) UK plug	1800-9011-01	•
Battery charger 0,5 A (10.8 V) UK plug	1800-9012-01	•



Petrol sweepers



	SWS 800 GE	SWS 800 G	SWS 600 G
Level	Experience	Essential	Essential
Art. N.	219802532/ST1	219802532/S17	219602532/S17
POWER			
Engine model	WS 210	WS 210	WS 210
Displacement	212 cc	212 cc	212 cc
Power	4.4 kW	4.4 kW	4.4 kW
Engine oil tank capacity	0.6 L	0.6 L	0.6 L
Engine oil type*	STIGA SAE 5W30	STIGA SAE 5W30	STIGA SAE 5W30
MAINTANANCE			
BELT			
118820750/0	•	•	•
118820755/0	•	•	•
SPARK PLUG			
9400-0244-00	RC12YC	•	•
AIR FILTER			
118551187/0	•	•	•
BRUSH 1			
118820392/0	20 pcs	•	•
118820392/0	26 pcs	•	•
BRUSH 2			
118820821/0	2 pcs	•	•
ACCESSORIES			
Collecting box	290602020/16	•	•
Collecting box	290802020/16	•	•
Front blade	290602030/16	•	•
Front blade	290802030/16	•	•

* More details on page: 100-101

Push sweepers



	SWP 577	SWP 475	SWP 355
Level	Experience	Experience	Essential
Art. N.	2W0775012/ST1	2W0755011/ST1	2W0552511/ST1
MAINTANANCE			
BRUSH 1			
118820857/1	2 pcs	•	•
118820838/0	•	•	•
BRUSH 2			
118820850/0	•	•	•
118820875/0	•	•	•

Corded high pressure cleaners



Code	Description	HPS 110	HPS 235 R	HPS 345 R	HPS 550 R	HPS 650 RG
1500-9000-01	Trigger gun T1	incl.				
1500-9001-01	Trigger gun T3		incl.	incl.		
1500-9002-01	Trigger gun T5				incl.	incl.
1500-9003-01	Rotary jet nozzle T1-T3	incl.	incl.	incl.		
1500-9004-01	Adjustable jet nozzle T1	incl.				
1500-9030-01	Adjustable jet nozzle T2		incl.			
1500-9005-01	Adjustable jet nozzle T3			incl.		
1500-9006-01	Lance extension T1	incl.				
1500-9007-01	Lance extension T3		incl.	incl.		
1500-9034-01	Extention lance	incl.	incl.	incl.		
1500-9035-01	Extention lance				incl.	incl.
1500-9008-01	Lance T5				incl.	incl.
1500-9009-01	Lance T5				incl.	incl.
1500-9010-01	HP hose 8m	incl.	incl.	incl.		
1500-9011-01	HP steel reinforced hose 12m				incl.	incl.
1500-9032-01	HP steel reinforced hose 9m			incl.		
1500-9033-01	Supersoft hose6 m		incl.			
1500-9031-01	Foam spray bottle kit 0.75 L	incl.	incl.	incl.		
1500-9013-01	Mini Patio	o	o	o		
1500-9014-01	Patio Deluxe				o	o
1500-9015-01	Fixed brush	o	o	o	o	o
1500-9016-01	Rotary Brush	o	o	o	o	o
1500-9017-01	Water suction kit	o	o	o	o	o
1500-9018-01	Pipe drain hose kit 10 m	o	o	o	o	o
1500-9019-01	Pipe drain hose kit 16 m	o	o	o	o	o
1500-9020-01	Underbody lance kit	o	o	o		
1500-9021-01	Hose extension 8m	o	o			
1500-9022-01	Hose extension 8m			o	o	o
1500-9023-01	Click fast kit	o	o	o	o	o
1500-9024-01	Inspectable water filter	incl.	incl.	incl.	incl.	incl.
1500-9025-01	Adaptors kit	o	o	o	o	o
1500-9026-01	Adaptors kit	o	o	o	o	o
1500-9027-01	Detergent	o	o	o	o	o
1500-9028-01	Detergent	o	o	o	o	o
1500-9029-01	Detergent	o	o	o	o	o

incl.= Included
O= Optional

Starting Kit Compact

Components	Q.ty	HPS 110	HPS 235 R	HPS 345 R	HPS 550 R	HPS 650 RG
Mani Patio quick connection	3	o	o	o		
Fixed brush	5	o	o	o	o	o
Rotary brush	5	o	o	o	o	o
HP hose extension 8 m	5	o	o			
Click fast kit	5	o	o	o	o	o
Inspectable water filter	5	o	o	o	o	o
Underbody lance kit	5	o	o			
Adaptors kit	5	o	o	o	o	o
Art. N.	2C0000000/ST1					

O = Optional

Starting Kit Premium

Components	Q.ty	HPS 110	HPS 235 R	HPS 345 R	HPS 550 R	HPS 650 RG
Mani Patio quick connection	3	o	o	o		
Patio Deluxe quick connection	3				o	o
Fixed brush	5	o	o	o	o	o
Rotary brush	5	o	o	o	o	o
Pipe drain hose kit 16 m	5				o	o
HP hose extension 8 m	5	o	o			
Reinforced HP hose extension 8 m	5	o	o		o	o
Click fast kit	5	o	o	o	o	o
Inspectable water filter	5	o	o	o	o	o
Underbody lance kit	5	o	o	o		
Adaptors kit	5	o	o	o	o	o
Art. N.	2C0000001/ST1					

O = Optional



ST 300e

SPARE PARTS AND ACCESSORIES

Battery snow throwers



	ST 700e Kit	ST 300e Kit
Level	Experience	Essential
Art. N.	2S1500108/ST1	2S1330108/ST1
POWER		
Voltage	48V	48V
Power	1000 W	450 W
Battery capacity	4 Ah	2 Ah
BELT		
118821317/0		•
118821249/0	•	
BATTERY		
277012008/ST1		incl.
277014008/ST1	incl.	O
277015008/ST1	O	O
277017008/ST1	O	
BATTERY CHARGER		
277020008/ST1 (EU)	incl.	incl.
277020208/ST1 EU)	O	O
277030008/ST1 (EU)	O	O
DIAGNOSTIC TOOL		
118810754/0	•	•
118811363/0	•	•

incl.= Included
O= Optional

Petrol snow throwers



	ST 976 T	ST 966	ST 7276 PH	ST 6272 P TRAC	ST 5266 P TRAC	ST 5266 P	ST 5262 P	ST 4262 P
Level	Expert	Expert	Expert	Experience	Experience	Experience	Experience	Essential
Art. N.	2S2767615/ST1	2S2667515/ST1	2S2767711/ST1	2S2726611/ST1	2S2666611/ST1	2S2664611/ST1	2S2624511/ST1	18-2841-31
POWER								
Engine model	WS 380 Powered by STIGA	WS 300 Powered by STIGA	WS 420	WS 380	WS 300	WS 300	WS 250	WS 210
Displacement	375 cc	302 cc	420 cc	375 cc	302 cc	302 cc	252 cc	212 cc
Power	7.8 kW	6.2 kW	9 kW	7.8 kW	6.2 kW	6.2 kW	5.2 kW	4.4 Kw
Engine oil tank capacity	1.1 L	0.95 L	0.95 L	0.95 L	0.95 L	0.95 L	0.95 L	0.95 L
Engine oil type*	STIGA SAE 5W-30	STIGA SAE 5W-30	STIGA SAE 5W-30	STIGA SAE 5W-30	STIGA SAE 5W-30	STIGA SAE 5W-30	STIGA SAE 5W-30	STIGA SAE 5W-30
MAINTANANCE								
BELT								
118820278/1				•			•	•
118820303/0							•	•
118821158/0				•	•	•		
118821185/0			•					
118821211/0			•					
135065703/0	•	•						
135065704/0	•	•						
SPARK PLUG								
9400-0289-01		RN9YC						
ACCESSORIES								
Skid shoe	1812-9036-01	•	•					
Skid shoe	118821102/0		•	•	•	•	•	•
Shear bolt	1812-9035-01	•	•					
Shear bolt	118821166/1		•	•	•	•		
Shear bolt	118820625/0						•	•
Protective cover	18-1936-61	•	•	•	•	•	•	•
Led bar	1812-9038-01	•	•					

* More details on page: 100-101

Petrol scarifiers



SVP 40 G

Level	Experience	
Art. N.	211400248/ST1	
POWER		
Displacement	182 cc	
Power	4 kW	
Engine oil tank capacity	0.95 L	
Engine oil type*	STIGA SAE 30	
MAINTANANCE		
BLADE		
118810244/0	32 pcs	•
118810237/0	12 pcs	•
SPARK PLUG		
9400-0289-01	RN9YC	•
AIR FILTER		
118550882/0		•

* More details on page: 100-101

Corded scarifiers



SV 415 E

SV 213 E

Level	Essential	
Art. N.	290002152/14	290002132/14
POWER		
Power	1.5 kW	1.3 kW
BLADE		
118802646/0	9 pcs	•
BELT		
118802681/0		•



SPARE PARTS AND ACCESSORIES

Petrol tillers



	SRC 685 RG	SRC 585 RG	SRC 36 V
Level	Experience	Experience	Essential
Art. N.	213851142/ST1	213601041/ST1	211360042/ST1
POWER			
Engine brand	STIGA	STIGA	STIGA
Engine model	TM 60	TM 60	ST 120 OHV Autochoke
Displacement	182 cc	182 cc	123 cc
Power	3.5 kW	3.5 kW	1.9 kW
Engine oil tank capacity	0.95 L	0.95 L	0.5 L
Engine oil type*	STIGA SAE 30 STIGA SAE 5W-30 STIGA SAE 10W-30	STIGA SAE 30 STIGA SAE 5W-30 STIGA SAE 10W-30	STIGA SAE 30
BELT			
118802845/0	•		
118806232/0		•	
118806226/0		•	
118802017/0			•
AIR FILTER			
118550882/0	•	•	
118550945/0			•
SPARK PLUG			
118550658/0	K7RTC		•
9400-0289-01	RN9YC	•	•
ACCESSORIES			
Half side plough	219001120/23		•
Half side plough	219000120/18	•	
Double side plough	219001220/23		•
Double side plough	219000130/18	•	
Iron wheels kit	219001250/23		•
Iron wheels kit	219000140/18	•	
Tires kit 16"	219000080/15	•	
Lateral wheels 12"	219001240/23		•
Potato plough	219001260/23		•
Connecting part	219001270/23		•

* More details on page: 100-101

48V Batteries and chargers



48V batteries

	E 475	E 450	E 440	E 420
Voltage	48V	48V	48V	48V
Capacity	7.5 Ah	5 Ah	4 Ah	2 Ah
Charging time fast / stand	180 min / 330 min	120 min / 220 min	110 min / 180 min	50 min / 90 min
Weight	2.12 kg	1.44 kg	1.36 kg	0.88 kg
Art. N.	277017008/ST1	277015008/ST1	277014008/ST1	277012008/ST1



48V chargers

	EC 415 D	EC 430 F	EC 415 S
Voltage	48V	48V	48V
Plug type	Eu plug	Eu plug	Eu plug
Type	Dual standard	Fast	Single standard
Output current	1.5 Ah	3 Ah	1.5 Ah
Art. N.	277020208/ST1	277030008/ST1	277020008/ST1

Battery harness

BH 900e

Voltage	48V
Capacity	Max. 2 batteries
Weight	3.85 kg
Art. N.	279050008/ST2



Battery simulator

E 400 S

Weight	0.35 kg
Art. N.	27010008/ST1



Battery belt

BB 700e

Tools Kit	Holder, belt, cable
Weight	1.42 kg
Art. N.	277040008/ST1



20V Batteries and chargers



20V batteries

	E 24	E 22
Voltage	20V	20V
Battery type	Lithium-ions	Lithium-ions
Capacity	4 Ah	2 Ah
Charging time	140 min	70 min
Weight	0.64 kg	0.39 kg
Art. N.	271014008/ST1	271012008/ST1



20V chargers

	C 215 D	C 215 S
Voltage	1.5 Ah	1.5 Ah
Plug type	Eu plug	Eu plug
Type	Dual standard	Single standard
Output current	2 A	2 A
Art. N.	271020100/21	271020000/21



Battery compatibility

48V Lawn mowers	7.5Ah	5Ah	4Ah	2Ah	Max working area	Max working time
Twinclip 950e V Kit	2 x	-	-	-	↗ 1100 m ²	⌚ 40'
Twinclip 950e VR Kit	2 x	-	-	-	↗ 950 m ²	⌚ 35'
Multiclip 747e V Kit	-	-	2 x	-	↗ 800 m ²	⌚ 40'
Multiclip 547e S Kit	-	-	2 x	-	↗ 800 m ²	⌚ 40'
Multiclip 547e Kit	-	-	1 x	-	↗ 500 m ²	⌚ 25'
Multiclip 547 AE Kit	-	-	1 x	-	↗ 500 m ²	⌚ 25'
Combi 753e V Kit	-	2 x	-	-	↗ 600 m ²	⌚ 25'
Combi 748e V Kit	-	-	2 x	-	↗ 550 m ²	⌚ 25'
Combi 344e Kit	-	1 x	-	-	↗ 400 m ²	⌚ 25'
Combi 340e Kit	-	-	1 x	-	↗ 350 m ²	⌚ 25'
Combi 336e Kit	-	-	-	1 x	↗ 200 m ²	⌚ 15'
Collector 548e S Kit	-	-	2 x	-	↗ 550 m ²	⌚ 25'
Collector 548 S AE	-	-	2 x	-	↗ 550 m ²	⌚ 25'
Collector 548 AE Kit	-	-	1 x	-	↗ 400 m ²	⌚ 15'
Collector 543e Kit	-	-	1 x	-	↗ 400 m ²	⌚ 22'
Collector 543 AE Kit	-	-	1 x	-	↗ 400 m ²	⌚ 22'

7.5 Ah battery E 475 5 Ah battery E 450 4 Ah battery E 440 2 Ah battery E 420



















































































20V Lawn mowers	4Ah	2Ah	Max working area	Max working time
Collector 140e Kit	2 x	-	↗ 350 m ²	⌚ 25'
Collector 136e Kit	-	2 x	↗ 250 m ²	⌚ 15'
Collector 132e Kit	1 x	-	↗ 150 m ²	⌚ 20'
Aero 132e Kit	2 x	-	↗ 100 m ²	⌚ 12'

4 Ah battery E 24 2 Ah battery E 22

Included battery and charger

TIGA

Battery compatibility

48V Garden tools			7.5Ah*	5Ah	4Ah	2Ah
Brushcutter bike handle¹ SBC 900 D AE		1x 5Ah	 35'	 25'	 20'	-
Brushcutter bike handle^{***} BC 700e B		1x 4Ah	 57'-113'	 38'-75'	 30'-60'	 15'-30'
Brushcutter loop handle^{**} BC 700e		-	 57'-113'	 38'-75'	 30'-60'	 15'-30'
Lawn trimmer¹ GT 500e		1x 2Ah	 75'	 50'	 40'	 20'
Pole hedger SPH 900 AE		-	 200'	 135'	 100'	-
Pole hedger PH 700e		-	 150'	 100'	 80'	 40'
Hedge trimmer¹ SHT 900 AE		1x 5Ah	 90'	 60'	 45'	-
Hedge trimmer¹ HT 500e		1x 2Ah	 188'	 125'	 100'	 50'
Pole saw PS 900e		-	 140'	 92'	 74'	-
Pole saw PS 700e		-	 56'	 38'	 30'	 15'
Chainsaw¹ CS 700e		1x 4Ah	 30'	 20'	 16'	-
Pruner PR 700e		-	 23'	 15'	 12'	-
Multi-tool (hedger)¹ MT 500e		1x 2Ah	 75'	 50'	 40'	 20'
Multi-tool (pruner)¹ MT 500e		1x 2Ah	 29'	 19'	 15'	 8'
Blower¹ SAB 900 AE		1x 5Ah	 50'	 35'	 26'	-
Blower^{***1} BL 500e		1x 2Ah	 38'-57'-245'	 25'-28'-163'	 20'-30'-130'	 10'-15'-65'
Snow thrower¹ ST 700e		1x 4Ah	 47'	 31'	 25'	-
Snow shovel¹ ST 300e		1x 2Ah	-	 47'	 38'	 19'

Battery harness
BH 900e

7.5Ah battery
E 475

4Ah battery
E 440

Battery belt
BB 700e

5Ah battery
E 450

2Ah battery
E 420

Battery harness is compulsory on 9 series tools with all batteries.
Battery simulator E 400 is compulsory to use battery belt
on 7 and 5 series tools.

Battery belt is compatible with all tools of 5, 7 and 9 series.
* Tools in 7 and 5 series need battery belt to work with 7.5Ah battery.
¹ Also available as bare tool





























Maximum working time
** Maximum/minimum cutting speed
*** Maximum/average/minimum air speed



Included battery
and charger



Sold separately

20V Garden tools	4Ah	2Ah	Max working time
Lawn trimmer GT 300e Kit	-	2 x 	 37'
Lawn trimmer GT 100e Kit	-	1 x 	 20'
Hedge trimmer HT 300e Kit	-	2 x 	 76'
Hedge trimmer HT 100e Kit	-	1 x 	 40'
Chainsaw CS 300e Kit	2 x 	-	 22'
Chainsaw CS 100e Kit	1 x 	-	 20'
Multi-tool (hedger) MT 100e Kit	1 x 	-	 75'
Multi-tool (pruner) MT 100e Kit	1 x 	-	 20'
Pruning shear SC 100e Kit	1 x 	-	 120'
Blower BL 300e Kit	2 x 	-	 37'
Blower BL 100e Kit	1 x 	-	 40'
Vacuum shredder (blower) VS 100e Kit	2 x 	-	 65' - 24'
Vacuum shredder (vacuum) VS 100e Kit	2 x 	-	 53' - 18'

4 Ah battery
E 24

2 Ah battery
E 22



Included battery
and charger

Lubricants and oil

Chain Oil

IDEAL FOR



Code	Pos.	Type	Capacity
1111-9228-01	1	Mineral	1 L
1111-9229-01	2	Mineral	5 L
1111-9276-01	3	Biodegradable	1 L
1111-9247-01	4	Biodegradable	5 L

2 Stroke Oil

IDEAL FOR



Code	Pos.	Type	Specification	Capacity
1111-9230-01	1	Synthetic 100%	API TC - JASO FD ISO-L-EGD	1 L dozer
1111-9231-01	2	Synthetic 100%	API TC - JASO FD ISO-L-EGD	0.1 L

Grease

1



Code	Pos.	Specification	Capacity	Fit for
1111-9298-01	1	Gear lubricant grease	125 gr	Brush cutters: all angle transmission and flexible shafts

IDEAL FOR



SAE 5W-30
ALSO IDEAL FOR



4 Stroke Oil

Code	Pos.	Type	Specification	Capacity
1111-9234-01	1	SAE 30	API SL/CF - ACEA A3/B4	0.6 L
1111-9235-01	2	SAE 30	API SL/CF - ACEA A3/B4	1 L
1111-9236-01	4	SAE 30	API SL/CF - ACEA A3/B4	1.4 L
1111-9237-01	3	SAE 10W-30	API SL/CF - ACEA A3/B4	0.6 L
1111-9238-01	5	SAE 10W-30	API SL/CF - ACEA A3/B4	1.4 L
1111-9242-01	6	SAE 5W-30	API SL/CF - ACEA A3/B4	1.4 L

Transmission Oil

IDEAL FOR



Code	Pos.	Type	Specification	Capacity
1111-92410-01	1	SAE 5W-40	API GL-4/GL-5	1.4 L
1111-9241-01	2	SAE 5W-40	API GL-4/GL-5	4 L
1111-9281-01	1	SAE 5W-50	API GL-4/GL-5 + LS	1.4 L
1111-9282-01	2	SAE 5W-50	API GL-4/GL-5 + LS	5 L
1111-9300-01	N.A.	SAE 5W-50	API GL-4/GL-5 + LS	60 L

Cans



Code	Pos.	Type	Capacity
1111-0001-01	1	Can	5 L
1911-9144-01	2	Combican	5 L + 2 L

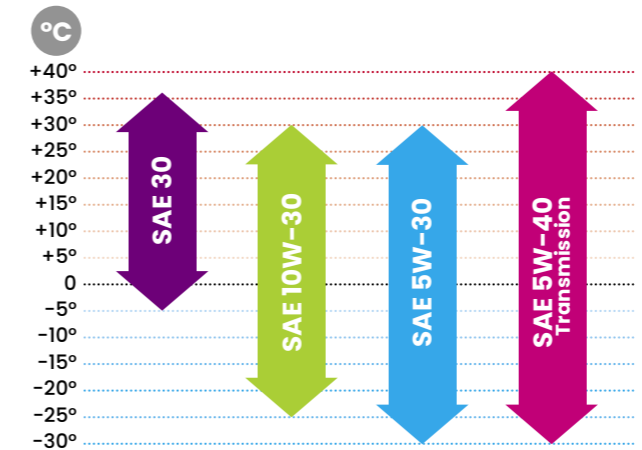

Temperature performance

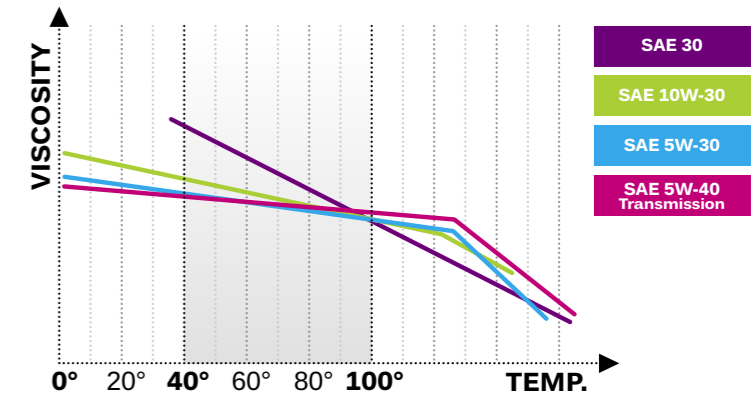

Viscosity performance

Operation/Frequency	Petrol lawn tractors			
	After first 5 hours	Every 5 hours or daily	Every 50 hours or every season	Every 100 hours
Check oil level		•		
Change oil 1)	•		•	
Clean silencer and engine		•		
Air filter check and cleaning 2)		•		
Air filter replacement			•	
Check spark plug			•	
Replace spark plug				•
Check fuel filter 3)				•

Petrol front mowers			
After first 5 hours	Every 5 hours or daily	Every 50 hours or every season	Every 100 hours
	•		
•			•
	•		
		•	
		•	
			•
			•

1) Change oil every 25 hours if the engine is operating under heavy load or in ht weather.
2) Clean air cleaner more frequently if the machine is operating in dusty areas.
3) To be carried out by a specialized Centre.

Trimmers lines



Square section

Code	Diameter (mm)	Length (m)	Type of pack
1911-9270-01	2.4	15	Small Donut
1911-9271-01	2.7	15	Small Donut
1911-9272-01	3.0	15	Small Donut
1911-9286-01	3.5	16	½ Dispenser
1911-9287-01	4	12	½ Dispenser
1911-9275-01	2.4	69	Medium Donut
1911-9276-01	2.7	55	Medium Donut
1911-9277-01	3.0	44	Medium Donut
1911-9278-01	3.5	32	Medium Donut
1911-9279-01	4	25	Medium Donut
1911-9280-01	2.4	345	Spool
1911-9281-01	2.7	275	Spool
1911-9282-01	3.0	220	Spool
1911-9283-01	3.5	160	Spool
1911-9284-01	4	125	Spool



Round tiger section

Code	Diameter (mm)	Length (m)	Type of pack
1911-9232-01	2.4	15	Small donut
1911-9233-01	2.7	15	Small donut
1911-9234-01	3.0	15	Small donut
1911-9254-01	3.5	9	Small donut
1911-9255-01	4.0	7	Small donut
1911-9235-01	2.4	88	Medium donut
1911-9236-01	2.7	70	Medium donut
1911-9237-01	3.0	56	Medium donut
1911-9252-01	3.5	41	Medium donut
1911-9253-01	4.0	32	Medium donut
1911-9238-01	2.4	437	Spool 3lb
1911-9239-01	3.0	279	Spool 3lb
1911-9256-01	3.5	205	Spool 3lb
1911-9257-01	4.0	156	Spool 3lb



Undulated section

Code	Diameter (mm)	Length (m)	Type of pack
1911-9240-01	1.6	15	Small donut
1911-9241-01	2.0	15	Small donut
1911-9242-01	2.4	15	Small donut
1911-9243-01	2.7	15	Small donut
1911-9244-01	3	15	Small donut
1911-9245-01	1.6	196	Medium donut
1911-9246-01	2.0	126	Medium donut
1911-9247-01	2.4	87	Medium donut
1911-9248-01	2.7	72	Medium donut
1911-9249-01	3	56	Medium donut

Type	Diameter mm	Battery trimmers	Corded trimmers	Petrol trimmers								
				GT 330 A	BC 730 B	BC 535 B	BC 740 B	BC 545 B	BC 750 B	BC 555 B	BC 760 B	
				MT 330 - 5in1	BC 730	BC 535	BC 740	BC 545	BC 750 R	BC 555 R		
						BC 330 AB			BC 750			
						BC 330 A						

Square section	2.4										
	2.7										
	2.8										
	3										
Round tiger section	2										
	2.4										
	2.7										
	2.8										
Undulated section	1.4										
	1.5										
	1.6										
	2										
Undulated section	2.5										

Safety clothing



Forestal jacket

Code	Description	Size
1599-1928-01	Forest jacket	S
1599-1928-11	Forest jacket	M
1599-1928-21	Forest jacket	L
1599-1928-31	Forest jacket	XL
1599-1928-41	Forest jacket	XXL



Protective trousers

Code	Description	Size
1599-1929-01	Protective trousers	S
1599-1929-11	Protective trousers	M
1599-1929-21	Protective trousers	L
1599-1929-31	Protective trousers	XL
1599-1929-41	Protective trousers	XXL



Protective leggings

Code	Description	Size
1599-1924-00	Protective leggings	One size



Technical gloves

Code	Description	Size
1599-1931-01	Technical gloves	8
1599-1931-11	Technical gloves	9
1599-1931-21	Technical gloves	10
1599-1931-31	Technical gloves	11
1599-1931-41	Technical gloves	12



Braces

Code	Pos.	Description	Size
1599-1941-00	1	Braces with loops	One size



Helmet

Code	Description	Size
1599-1913-11	Helmet	One size

XXXXX/24EN

A hedgehog is shown in profile, facing right, in a grassy field at night. The hedgehog is illuminated by a spotlight, making its spines and face stand out against the dark background. The grass is also lit, creating a soft glow around the hedgehog.

STIGA S.p.A.
via del Lavoro 6
31033 Castelfranco V. (TV)
Italy

stiga.com

STIGA reserves the right to make changes to products without prior notice.